

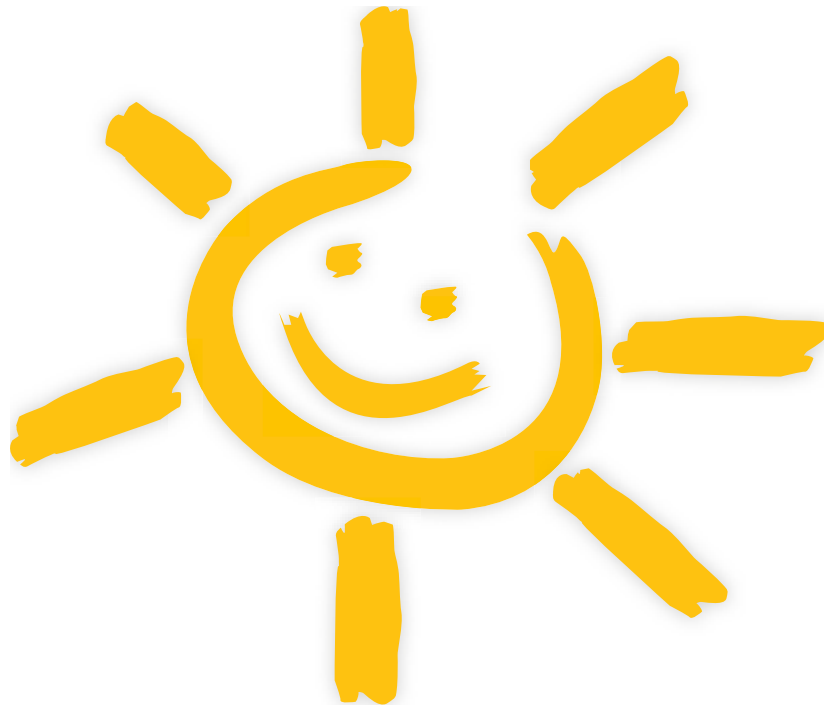

Productcatalogus 2020/2021



Kinderen • beleving • kwaliteit • creativiteit • concept • verbeelding • educatie

www.novumvoorkids.nl



Contact



Telephone:

Tel.: 075 3030374



E-mail:

info@novumvoorkids.nl



Portal:

www.novumvoorkids.nl

Customer Service:



Novum

Ronde tocht 7a

1507 CC Zaandam

openingstijden 08.30 - 17.00

Correspondence:



Novum

Ronde tocht 7a

1507 CC Zaandam

Nederland

Alles op gebied van een veilige en kindvriendelijke omgeving



Certificates confirming safety of our foam shapes

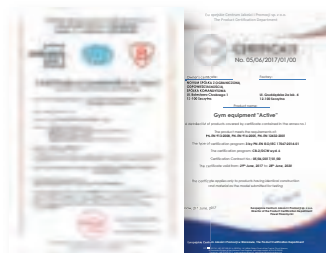

Certificates concerning our production standards



For the production of our devices we use raw materials sourced with the use of FSC



We also hold ISO 9001 certificate



NOVUM stands for quality and reliability



FURNITURE

Furniture bodies, fronts and all applications are made from either solid wood, plywood, double lacquered MDF or chipboard.

With care for the youngest users' safety every piece of furniture has rounded edges. Our furniture is functional, stable and long lasting.

Fittings used in our furniture is of highest quality and is purchased from well known suppliers.

When we are designing furniture, we try to connect interesting, colourful patterns with comfort and functionality.

EXTRAORDINARY CHAIRS AND TABLES

Chairs and tables embedded on the metal frame are of the highest quality, painted with powder technology, which is resistant to scratches and dipping of the paint.

Stable construction, simple and reliable system of the regulation, possibility of choosing colour.

We design plywood seats in the way which ensures ergonomics.

If you have decided to purchase NOVUM products, you have made the right choice! Trust our experience! All our products are made of high quality raw materials, which are certificated and don't contain any hazardous substances.



FOAM AND GRANULATE

This series is made of springy, soft distortion-free, polyurethane foam, extended with seats filled with granulate, silicone and others fillings and it is just excellent for rehabilitation and relaxation.

Each foam is covered with certified phthalate-free high quality fabrics.

Fabric is perfectly matched with foam shape. Excellent manufacturing processes guarantee safety and long time of usage.

PLAYGROUNDS

Wide range of play equipment and a possibility to choose materials (wood and steel).

In addition to traditional devices for playgrounds we offer toddlers series for children in age range 0-3 years, fitness equipment, street workouts and dog park equipment.

We guarantee availability of spare parts for 10 years. Many years of experience results in high quality, reliability and safety in this field.



Smart Kids
Academy



Edullica



Green
Kindergarten



Kindergarten 31
in Płock



Park
in Miława



School
in Jaktorów



Relaxation areas

bestseller
on page 116



PLAYPEN PUZZLE

NEW

Made of foam, trimmed with polyester.



relaxation areas



ANTI-SLIP

RECOMMENDED CARE



Playpen Puzzle
Dim.: L. 150 x W. 150 x H. 70 cm

4641345

PLAYPEN CONSISTS OF 4 ELEMENTS CONNECTED WITH VELCRO

TIME TO RELAX!

Made of foam, trimmed with polyester.



NEW

NEW UPHOLSTERY TEXTILE TORNADO



Recommended care



Comfortable, folding, soft, little sofas for relaxation areas. Made of elastic foam resistant to deformation, upholstered with easy to clean textile. It does not take a lot of place after folding. Perfect for relaxation, especially during therapeutic sessions with children.



1



2



Security provides Oeko-Tex certificate



removable cover with ZIPPER

NEW



relaxation areas

Foldable sofa Relax

Dim. L. 120 x W. 40 x H. 40 cm

4641132 gray - pink

4641134 gray - blue



Made of foam, trimmed with artificial leather.

Comfortable, folding, soft, little sofa for a rest room. Made of elastic foam resistant to deformation, upholstered with easy to clean material. After folding it does not take a lot of place. Perfect for relaxation, especially on child care therapeutic sessions. Set contains one pillow.

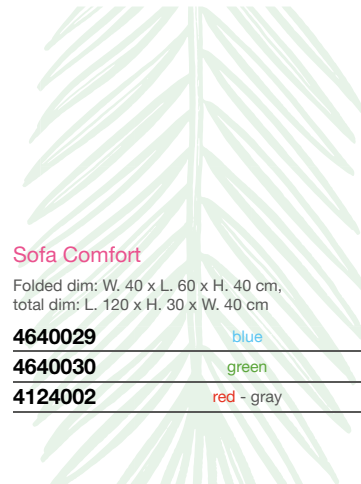

Sofa Comfort

Folded dim: W. 40 x L. 60 x H. 40 cm,
total dim: L. 120 x H. 30 x W. 40 cm

4640029	blue
4640030	green
4124002	red - gray

COMFORTABLE ARMCHAIR OR COUCH

NEW

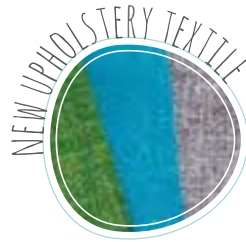

Foam chair

Foam chair made of foam, covered with polyester cover with zipping. Includes two small cushions. Dimensions after folding: L. 60 x W. 50 x H. 50 cm. Dimensions when unfolded: L. 137 x W. 50 x H. 15 cm

4641192 gray - blue

4641191 gray - green

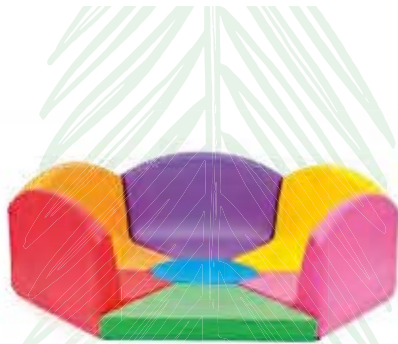

Crocus soft foam seat

Functional hexagon set consist of colourful, foam seats, with rounded, arched backs, additional circle in the middle and one element serving as an entrance. In this crocus can play several children. The set consists of 5 elements with the backrest, circle, and the entrance. Dim.: H. 54 x Dia. 157 cm

4521130L



Made of foam, trimmed with artificial leather.

relaxation areas

Filled with granulate and wrenched foam mix, trimmed with artificial leather.

PAWS AND HEAD FILLED WITH
STYROFOAM GRANULATE, WITH
ANTI-SLIP MATERIAL ON THE BOTTOM



COLOURFUL CUSHION FILLED WITH
PELLETS, SO IT IS VERY SOFT; COVER
MADE OF ARTIFICIAL LEATHER



RIM MADE OF FOAM

Turtle - playpen

Dim.: L. 140 x W. 140 x H. 30 cm
Rim dim.: Dia. 105 x H. 30 cm

4640801



1. Cylinder with granulate pink

Dim.: L. 118 x W. 20 x H. 13 cm

4640896

2. Cylinder with granulate green

Dim.: L. 118 x W. 20 x H. 13 cm

4640895

3. Triangular mattress

Dim.: L. 120 x W. 120 x H. 7 cm

4640897

Made of foam, trimmed with artificial leather, styrofoam granulate inside the rollers.



CYLINDERS ARE SOLD SEPARATELY

TRIANGULAR MATTRESS

the bottom of one of a triangle is trimmed with a non-slip material

Made of foam, trimmed with artificial leather.



4. Half round mattress

Dim. of unfolded mattress: L. 320 x W. 160 x H. 6 cm, folded mattress: L. 160 x W. 160 x H. 12 cm

4640892



relaxation areas

CORNER MATTRESS

Made of foam, trimmed with artificial leather.



PERFECT FOR THE RELAXATION AREA



1. Corner mattress Ocean

Dim.: H. 10 x W. 150 x L. 150 cm

4641190

2. Corner mattress Meadow

Dim.: L. 150 x W. 150 x H. 10 cm

4640611

3. Rocking in the clouds

Dim.: H. 50 x W. 140 x L. 140 cm

4641234

4. Green glade

Dim.: H. 50 x W. 140 x L. 140 cm

4641235

KINDERGARTEN MATTRESSES

Made of foam, trimmed with artificial leather.



ANTI-SLIP



Small mattresses made of stiff polyurethane foam covered with phthalate-free meditap material and non-slip fabric.

1. Kindergarten mattresses

Dim.: L. 120 x W. 60 x H. 6 cm

4640076	blue
4640075	yellow
4640074	green



- meditap fabric (artificial leather) and strong cotton makes it easy to keep foam shape clean – greasiness can be removed with the use of water and soap,
- meditap is the phthalate-free fabric with Oeko-Tex Standard 100 Certificate,
- every material used for foam cover is certified,
- the fabric is not only nice to touch but also durable and non-flammable,
- covers are precisely fitted to the shape of particular foam.



relaxation areas

COLOURFUL PETS MATTRESSES



FOR PLAY AND RELAX
CORNERS

Made of foam, trimmed
with artificial leather.



NEW

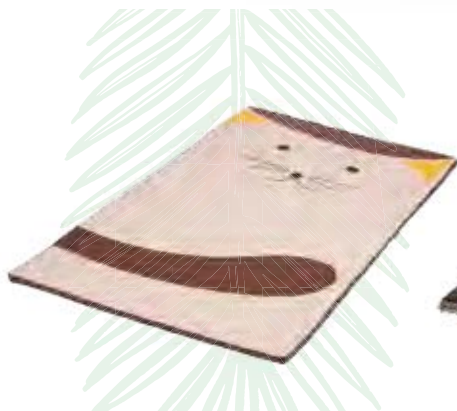

Mat Cat

Dim.: L. 120 x W. 70 x H. 3 cm

4641123

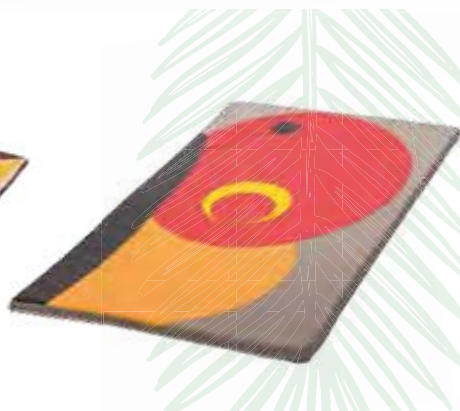

Mat Butterfly

Dim.: L. 120 x W. 70 x H. 3 cm

4641127

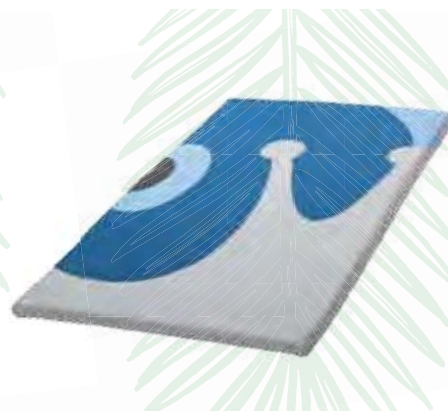

Mat Snail

Dim.: L. 120 x W. 70 x H. 3 cm

4641129

Made of foam, trimmed with artificial leather.

MORE ON
WWW.NOVUMKIDS.COM

FILLED WITH SILICONE

FILLED WITH RUSTING FOIL



FILLED WITH SILICONE

FILLED WITH SILICONE

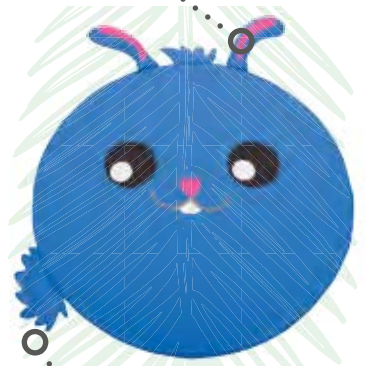

FILLED WITH RUSTING FOIL

Round mattress Piggy
Dim.: Dia. 110 x H. 3 cm
4641040

Round mattress Rabbit
Dim.: Dia. 110 x H. 3 cm
4641037

Round mattress Fox
Dim.: Dia. 110 x H. 3 cm
4641039

relaxation areas

MATTRESSES WITH SAFE MIRRORS

Made of foam, trimmed with artificial leather.

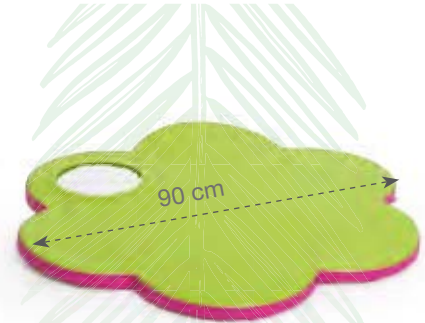

Flower - mat

Dim.: L. 90 x W. 90 x H. 4 cm

4640831



looking into differently sized mirrors provides babies with interesting experiences

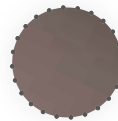
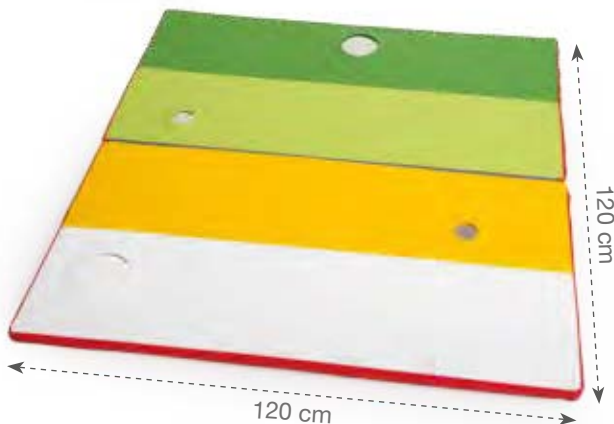

ANTI-SLIP



Tested for harmful substances
according to Oeko-Tex® Standard 100
IW 00113

IW

Security provides
Oeko-Tex certificate

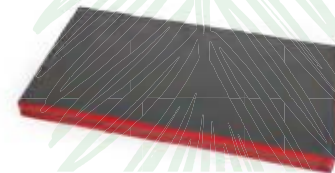

Mirror square - mattress

available in folded version

Dim.: L. 120 x W. 120 x H. 4 cm

4641303

SENSORY MATTRESSES

Made of foam, trimmed
with artificial leather.



SAFE MIRROR



Shapes - folding mattress
Dim.: L. 180 x W. 70 x H. 4 cm

4640790



relaxation areas

Play areas

bestseller
on page 135



Made of 12 mm birch plywood,
lacquered with ecological water-
lacquers

ATTRACTIVE PARTITIONS AND INTERESTING HANDLING WALLS IN ONE!



1. Zigzag - partition

Dim.: H. 65 x W. 80 x D. 1,2 cm,
width of the base: 30 cm

6512466



2. Fence - partition

Dim.: H. 65 x W. 80 x D. 1,2 cm,
width of the base: 30 cm

6512465



3. Gate - partition

Dim.: H. 65 x W. 80 x D. 1,2 cm

6512464



4. Turning wheel - partition

Dim.: H. 65 x W. 80 x D. 12 cm,
width of the base: 30 cm

6512472



5. House - partition

There are blue curtains on one side. Dim.: H. 65 x W.
80 x D. 1,2 cm, width of the base: 30 cm

6512471

6. Maze - partition

Dim.: H. 65 x W. 80 x D. 1,2 cm,
width of the base: 30 cm

6512470



1. Colourful Window - partition

Dim.: H. 65 x W. 80 x D. 1,2 cm,
width of the base: 30 cm

6512469



2. Mirrors - partition

On one side the mirrors are fixed vertically,
on the other - horizontally. Dim.: H. 65 x W. 80
x D. 1,2 cm, width of the base: 30 cm

6512468

3. Cat - partition

Dim.: H. 65 x W. 80 x D. 1,2 cm,
width of the base: 30 cm

6512467

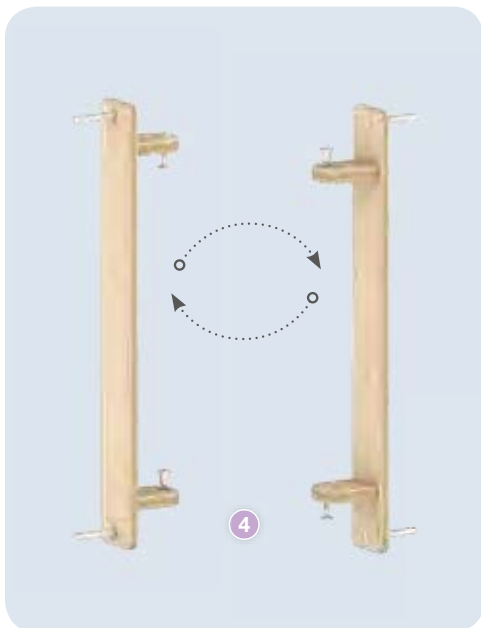

4



5



6



7

COMPLEMENTARY ELEMENTS

4. Slats to fix partition to the walls

Dim.: H. 46 x W. 6 x D. 6 cm
2 pcs

6512462

5. Connector T

Allows to fix partitions with each other at an angle
of 90 degrees, which creates a free-standing
manipulation walls. 2 pcs. Dim.: H. 12,2 x W. 8,6 x
thick. 1,5 cm

6512473

6. Connector Y

Allows to fix partition with each other at an angle
of 60 degrees, which creates a free-standing
manipulation walls. 2 pcs. Dim.: H. 12,3 x W. 11 x
thick. 1,5 cm

6512463

7. Connector X

Dim.: W. 12 x D. 12 x H. 1,5 cm

6512474

BY USING CONNECTOR Y, CONNECTOR T OR CONNECTOR X YOU CAN CREATE A FREE-STANDING PLAYING SPACE.



GATE PARTITION IS EQUIPPED WITH A LOCK.
IT IS AS A MOVABLE MODULE WICH ALLOWS TO
OPEN AND CLOSE THE SPACE.

NEW

1. Mattress for partitions
Dim.: L. 80 x W. 80 x H. 7 cm

4641354

blue

4641355

green

play areas



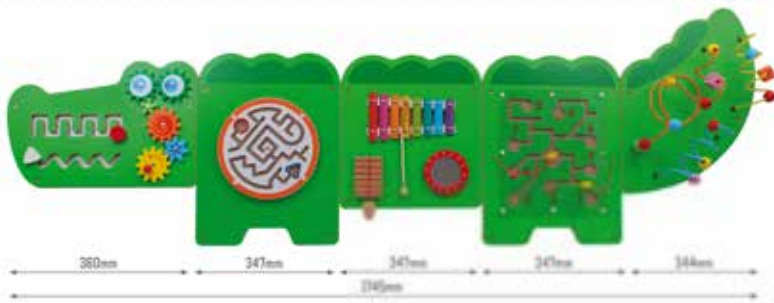

Crocodile

Consisting of 5 elements panel guarantees lots of fun. Helps to develop hand-eye coordination and motor skills.

Dim.: W. 174,5 cm

6303210



WINDOWS WITH COLOURED
PLEXIGLASS

YELLOW MATTRESS ON THE FLOOR

DIFFERENT MANIPULATIONS

Made of birch, lacquered plywood.
Mattresses included.



Playhouse Katie

Dim.: H. 130 x W. 115 x D. 51 cm

6512395

Made of beech wood, colourful applications made of painted birch plywood, with safe mirror.



Meadow mirror with handrail

Mirror designed for younger children. Strong, beech wood bar fastened in the middle helps toddlers to get up and take their first steps. Applications painted with environmentally-friendly water paints.

Dim.: W. 130 x H. 80 cm

APPLICATIONS OF BIRCH PLYWOOD

Safe mirror with a wooden frame.

MIRRORS ARE VERY USEFUL IN A KINDERGARTEN. CHILDREN LOVE TO PLAY WITH THEM. MAKING FUNNY FACES AND POSES IS ONE OF THEIR FAVOURITE GAMES.

Mirror

Dim.: W. 130 x H. 80 cm

4122509



SHOPS AND STALLS

Made of wood.

MOVABLE COUNTER

SPACIOUS SHELVES



Small stall

A great way to arrange interior of your school or kindergarten. Stall consists of: three shelves for articles and mobile counter with two shelves.
Dim.: H. 116 x W. 83 x D. 77 cm

4122110

Decorations not included.



Decorations not included.

Made of wood.

Shop with a counter

Lovely and functional shop, made of wood, with many shelves and large counters gives possibility for many children to play simultaneously. Decorations not included. Dim.: H. 155 x W. 120 x D. 105 cm

4122120

DRAWERS MAKE IT EASY
TO MAINTAIN ORDER

STRONGLY CONNECTED





KITCHEN PLAY CORNERS



PLYWOOD KITCHENS

Made of plywood,
lacquered with water
paints.

MULTI CORNERS

1. Plywood corner kitchen,
white

Dim.: H. 75 x W. 115 x L. 75 cm

6512460A

2. Plywood corner kitchen,
green

Dim.: H. 75 x W. 115 x L. 75 cm

6512460C



1



2

SINGLE WHITE

3. Kitchen microwave, white

Dim.: H. 61 x W. 40 x D. 30 cm

4122503H

4. Kitchen sink, white

Dim.: H. 61 x W. 40 x D. 30 cm

4122504H

5. Washing machine, white

Dim.: H. 61 x W. 40 x D. 30 cm

4122501H

6. Cooker, white

Dim.: H. 61 x W. 40 x D. 30 cm

4122502H



3



4



5



6

7. Microwave

Dim.: H. 61 x W. 40 x D. 30 cm

4122503

8. Sink

Dim.: H. 61 x W. 40 x D. 30 cm

4122504

9. Washing machine

Dim.: H. 61 x W. 40 x D. 30 cm

4122501

10. Cooker

Dim.: H. 61 x W. 40 x D. 30 cm

4122502



7



8



9



10

SINGLE COLOURED

play areas

WASHER - DRYER



OPEN DOORS

Made of plywood, lacquered with water paints.



Washer-dryer with ironing board
Dim.: H. 60 x W. 94,5 x D. 30 cm

6512572

Accessories not included.
Clothes pins code: 6301780

WORKSHOP



MOVING GEARS

OPEN DOORS



Workshop

Dim.: H. 90 x W. 90 x D. 30 cm

6512571

Accessories not included. Tool set
code 6305236

PLAYING WITH AMELKA KITCHEN

Body made of chipboard, fronts made of laminated MDF.



1. Microwave Amelka

The ideal supplement to the corner of the kitchen. It has two movable knobs, and a convenient handle to open the door.

Dim.: H. 22 x W. 35 x D. 31 cm

6512315

2. Dishwasher Amelka

It has a movable knob, and a convenient handle to open the door, behind which there are shelves for dishes.

Dim.: H. 50 x W. 40 x D. 36 cm

6512314

3. Amelka fridge

This great fridge made with special attention to details. There are shelves for food products inside. Material: body of laminated chipboard, laminated MDF fronts-in. Dim.: H. 100 x W. 40 x D. 30 cm

6512250

4. Amelka kitchen

High-quality, beautiful kitchen with a sink. It has hot plates, movable knobs and practical shelf for kitchen accessories. Behind the door are shelves for dishes. Blue classic kitchen is an essential component of any play corner, provides plenty of fun for children. Material: the body made of laminated chipboard, fronts made of laminated MDF, table top made of plywood. Dim.: H. 80 x W. 78 x D. 32 cm

Working table height: 50 cm

6521125



play areas

FURNITURE DAISY



A BIG SAFE MIRROR
STABLE CONSTRUCTION



FUNCTIONAL DRAWER

Body made of chipboard,
colourful elements made of
lacquered MDF.



Daisy dressing unit

Dim.: H. 97 x W. 50 x D. 42 cm

6512253

Daisy stool

The top of the stool is made of painted plywood,
legs made of laminated wood, leaves from painted
MDF. Dim.: H. 26 x W. 28 x D. 28 cm

6512254

DRESSING UNIT PINK



A BIG SAFE MIRROR
FUNCTIONAL DRAWER

Made of painted plywood.

BESTSELLER

Dressing unit pink

Dim.: H. 103 x W. 70 x D. 41 cm

4520241

dressing unit

Dim.: H. 30 x W. 30 x D. 30 cm

4520233R

stool

DAISY CABINET

Body made of chipboard,
colourful elements made of
lacquered MDF.



SAFE MIRRORS

ROUNDED CORNERS

STABLE CONSTRUCTION

PULLED OUT, CAPACIOUS CONTAINERS

5 SOFT FOAMS SEATS INCLUDED

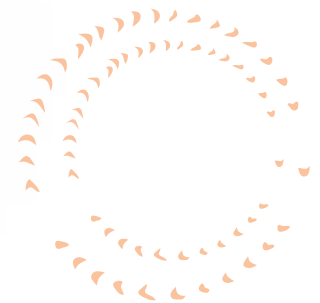

Daisy cabinet

Multifunctional cabinet. Two safe mirrors two
practical containers on wheels for toys storing five
colour foam seating.

Dim.: H. 97 x W. 103 x D. 36 cm

6512246



play areas

Art & Craft



bestseller

Made of lacquered plywood.

MINI MUSIC ISLAND

6 DIFFERENT
INSTRUMENTS

• 2nd side



• TRIANGLES AND BELLS

• 1st side



• BOWLS AND PLATE
• CYMBALS AND CHIMES

• 3rd side



• CHIMES AND CYMBALS



DOESN'T TAKE MUCH
SPACE AFTER FOLDING

Mini music island

Dim.: H. 90,5 x W. 151 x D. 149 cm

6512558

MUSICAL INSTRUMENTS CABINETS



HANGERS FOR
INSTRUMENTS



Made of lacquered plywood,
sides of laminated MDF.

Saxophone cabinet for instruments
Mobile furniture equipped with shelves, bars and
hangers, which helps to store instruments.
Dim.: H. 80 x W. 72 x D. 65 cm

4520722



Made of laquered
plywood.

Multiart unit
Dim.: H. 90 x W. 50 x L. 93 cm

4122103



Made of laquered
plywood.

Music cabinet
Dim.: H. 90 x W. 50 x L. 93 cm

4122102



STORAGE FOR ARTROOMS

Frame made of laminated board.
Side shelves made of plexiglass for
cartons and paper storing.



Cabinet for art accessories
Dim.: W. 102 x H. 68,3 x D. 50 cm

6512255



PLEXIGLASS
CONTAINER FOR
BRISTOL, PAPER
AND LARGE
FORMAT PAPERS



WHEELS FOR EASY
MANEUVERING

art & craft

Made of plywood, equipped
with removable organiser with
compartments.



**Double side multifunctional cabinet for
art accessories**

Practical furniture for art&craft storage. The shelving
system includes a space for paints, crayons,
brushes which can be separated thanks to the
special removable insert which is on the top of the
cabinet.

Dim.: H. 80 x W. 90 x D. 50 cm

4122090



REMOVABLE
INSERT



STAND FOR
BRISTOL





Double-sided easel for 8 kids

Shelf and work surface made of raw MDF board. Frame made of plywood. Dim.: H. 120 x L. 200 x D. 75 cm. Shelf dim.: 200 x 60 cm. Set contains 8 paper clips.

4520299



Small easel

Made of plywood, working area made of varnished MDF board. Sold without papier roll. Board to paint dim.: 70 x 60 cm. Dim.: H. 122 x W. 90 x D. 60 cm

4122095



Paper roll 50 m

Dim.: L. 50 m x W. 60 cm

4570001

DRYERS FOR ART WORKS

Bars made of powder-coated steel,
body made of durable plywood
with a thickness, applications made
of laminated MDF.



Elephant - double dryer for art works

26 racks for art drying.
Dryer dim.: H. 96 x W. 77 x D. 34 cm
Dim. of the metal frame: 32 x 34 cm

45200043



Standard dryer for art works

25 racks for art drying.
Dryer dim.: H. 83 x W. 36 x D. 38 cm
Dim. of the metal frame: 32 x 34 cm

4520003



Giraffe dryer for art works

25 racks for art drying.
Dryer dim.: H. 93 x W. 36 x D. 51 cm
Dim. of the metal frame: 32 x 34 cm

45200041



Dino dryer for art works

25 racks for art drying.
Dryer dim.: H. 91 x W. 36 x D. 51 cm
Dim. of the metal frame: 32 x 34 cm

45200042



Hanger with clips

Excellent for art works. Made of lacquered
plywood. Dim.: H. 10 x W. 150 x D. 1,5 cm

6512553



Hangers for aprons and towels

Made of lacquered plywood.
Dim.: H. 65 x W. 8 x D. 2 cm

6512554



Frame made of beech wood

TIME TO START THE SHOW

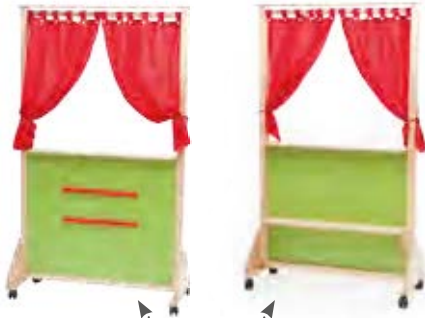

FRONT BACK

Red Curtain theater
 Colourful theater encourage toddlers for art expression and playing with puppets. Decorative fabric curtains attract every play corner. On one side there is a shelf for puppets and on the other side there is a place to put show's title.
 Dim.: H. 144 x W. 90 cm
4124900

Made of durable plywood.

THEATER AND SHOP 2 IN 1



DOUBLE-SIDED

art & craft

Theater & Shop wall

A great solution where kids can play with puppets, when kids end their fun in theater they can turn it around and start playing in a shop. There is 6 shelves and 2 drawers, where you can keep your goods.

Dim.: H. 100 x W. 110 x D. 99 cm

4510006

- DURABLE AND STABLE
- PAINTED WITH SAFE PAINT AND WATER-BASED VARNISHES
- PERFECT FOR PLAYING THE ROLE PLAY

Changing units, bathrooms

bestseller
on page 150





CAPACIOUS DRAWERS



METAL RUNNERS



MILD NOTCH INSTEAD OF A HANDLE



DAMPER TO PREVENT SLAMMING



Made of maple chipboard, mattress made of foam trimmed with artificial leather.



Mattress available on cat. no. 4641339

changing units, bathrooms



Changing unit with doors
The changing unit contains 6 adjustable shelves. Mattress not included. Dim.: H. 108 x W. 100 x D. 76 cm

6522004



Changing unit with drawers
The changing unit contains 8 drawers. There are gentle notches instead of handles. Mattress not included. Dim.: H. 108 x W. 100 x D. 76 cm

6522001



Changing unit with drawers left
The changing unit contains 4 spacious drawers on the left and 3 shelves on the right. Drawers have gentle notches instead of handles. Mattress not included. Dim.: H. 108 x W. 100 x D. 76 cm

6522002



Changing unit with drawers right
The changing unit contains 4 spacious drawers on the right and 3 shelves on the left. Drawers have gentle notches instead of handles. Mattress not included. Dim.: H. 108 x W. 100 x D. 76 cm

6522003

BABY CHANGING UNITS WITH STAIRS



Made of lacquered plywood.



Made of maple chipboard.



DOOR CLOSED WITH LATCH



POWDER COATED HANDRAIL



CUT-OUTS IN THE DRAWERS REPLACE HANDLES



HINGES TO OPEN THE DOOR AT 270°



FULLY-EXTENDING DRAWERS FOR A BETTER USE



BASE MADE OF WATER RESISTANT, 15MM HDPE BOARD

Baby changing units with stairs

LEFT



plywood

Dim.: H. 108 x W. 120 x D. 90 cm

6512600EX

RIGHT



plywood

Dim.: H. 108 x W. 120 x D. 90 cm

6512601EX

LEFT



chipboard

Dim.: H. 109 x W. 121,5 x D. 90 cm

6512602EX

RIGHT



chipboard

Dim.: H. 109 x W. 121,5 x D. 90 cm

6512603EX

Mattress

made of foam, trimmed with meditap



NEW

green

blue

Dim.: H.3 x W. 74 x L. 87 cm

4641298

4641299

BABY CHANGING UNITS CHEST WITH 10 DRAWERS



Made of lacquered plywood.

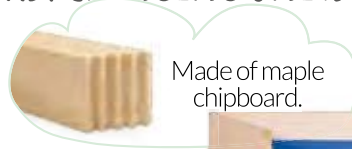

Made of maple chipboard.



MATRESS FITTED TO THE TOP OF THE CHANGING TABLE



VERY SILENT BEARING SLIDER



FULLY-EXTENDING DRAWERS FOR A BETTER USE



LOCKABLE, CAPACIOUS SHELVES



HINGES TO OPEN THE DOOR AT 270°



BASE MADE OF WATER RESISTANT, 15MM HDPE BOARD

changing units, bathrooms

Mattress

made of foam, trimmed with meditap



green

blue

Dim.: H. 15 x W. 88 x L. 101 cm

4641300

4641301

Baby changing units with chest with 10 drawers

LEFT



plywood

Dim.: H. 108 x W. 104 x D. 90 cm

6512596EX

RIGHT



plywood

Dim.: H. 108 x W. 104 x D. 90 cm

6512597EX

LEFT



chipboard

Dim.: H. 109 x W. 105 x D. 90 cm

6512598EX

RIGHT



chipboard

Dim.: H. 109 x W. 105 x D. 90 cm

6512599EX

BABY CHANGING UNITS FOR GRATNELLS CONTAINERS



Made of lacquered plywood.



Made of maple chipboard.



LARGE SURFACE OF THE CHANGING TABLE TOP



BASE MADE OF WATER RESISTANT, 15MM HDPE BOARD



FULLY-EXTENDING DRAWERS FOR A BETTER USE



MANY POSSIBILITIES FOR CONTAINERS CONFIGURATION
CONTAINERS AND RUNNERS ARE SOLD SEPARATELY. LOOK AT THE PAGE 29

Baby changing units for Gratnells containers



plywood

Dim.: H. 108 x W. 103 x D. 90 cm

6512594EX



chipboard

Dim.: H. 109 x W. 104 x D. 90 cm

6512595EX

Mattress



green

blue

Dim.: H. 15 x W. 88 x L. 101 cm

4641300

4641301

2 TYPES OF MATERIALS



PLYWOOD:

is more resistant to moisture, has a high strength, is one of the most environmentally friendly materials



CHIPBOARD:

the chipboard has a high abrasion resistance, is also UV resistant, environmentally friendly wood-based material



DOORS MADE OF LACQUERED MDF



Cabinet for nappies

Dim.: H. 51 x W. 92 x D. 29 cm

6512271

Doors for nappies cabinet

6512272 yellow

6512273 blue

6512275 green

6512274 red



The chipboard design ensures the stability of the entire structure. The high side panels are additional protection for the baby, and the practical mattress makes the pads soft. Two large shelves can be used to store baby care accessories.



Baby changing table with shelves

Dim.: H. 105 x W. 65 x D. 80 cm

6512270

Mattress for changing table

4641057 yellow

4641058 red

4641059 blue

4641060 green

MATTRESSES TRIMMED WITH AN EASY TO CLEAN ARTIFICIAL LEATHER

changing units, bathrooms



1. Cups

Colour cups fitting to the shelf are made from durable plastic.

4520288



2. Shelf for 27 cups

Dim.: H. 51,5 x W. 62 x D. 24 cm

6512552



3. Cup shelf

Dim.: H. 40 x W. 62 x D. 22 cm

6300021



cups sold separately



4. Boat cup shelf with hangers

Dim.: H. 43 x L. 110 x D. 22 cm

4122064

5. Cup shelf with hangers

Dim.: H. 23 x L. 125 x D. 22 cm

4122065

Beds and beddings

bestseller
on page 158



BED MINI MAX

5

years

GUARANTEE



COMFORTABLE BEDS FOR KINDERGARTENS AND NURSERIES

Modern beds made from approved plastic material serve as a perfect solution for your room. Hygienic, air permeable material is easy to clean. Beds are very comfortable and light. Can be moved and stacked without necessary effort.

Due to the body temperature fabric adapts to the body shape

Solid connection of fabric with bed frame provides safe rest

Space-saving construction enables beds to be put one on the top of the other



1. Bed MAX

Dim.: H. 11 x W. 137 x D. 56 cm

4945730

2. Bed MINI

Dim.: H. 11 x W. 102 x D. 55 cm

6303118

3. Platform for MAX beds

Aluminum. Dim.: L. 132 x W. 56 cm

4945735A

4. Platform for MINI beds

Aluminum. Dim.: L. 83,5 x W. 54,5 cm

4945736A



5. Mattress for MAX beds

Dim.: L. 124 x W. 50 x H. 3 cm

4641087

6. Mattress for MINI beds

Dim.: L. 95 x W. 49 x H. 3 cm

4641088



Beddingcase
100% cotton

BEDDING FOR BEDS MINI



1. Sleeping bag with a pillow
Pillow dim.: L. 35 x W. 55 cm, sleeping bag dim.: L. 90 x W. 70 cm

4640813



2. Sleeping bag with a pillow in a cover
Cover dim.: L. 42 x W. 42 cm

4640814



3. Beddingcase

Set of cotton sheets fastened to the tab.
Dim. of the pillow: 55 x 35 cm, dim. of the blanket: L. 100 x W. 70 cm, dim. of the sheet: L. 93 x W. 60 cm

4640815



4. Pillow with a name
Dim.: L. 35 x W. 35 cm

4640812

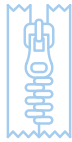

Beddingcase
100% cotton

BEDDING FOR BEDS MAX



1. Sleeping bag with pillow

Sleeping bag dim.: W. 70 x L. 110 cm,
dim. of the pillow: L. 35 x W. 35 cm

4641093 white - blue

4641094 gray - white

2. Gingerbread bedding

Blanket dim.: W. 95 x L. 125
cm, dim. of the pillow: L. 35 x
W. 35 cm

4641096 white - blue

4641097 gray - white

Blanket dim.: W. 95 x L. 145
cm, dim. of the pillow: L. 35 x
W. 35 cm

4641105 white - blue

4641106 gray - white

3. Gingerbread beddingcase

Blanket dim.: W. 95 x L. 125
cm, dim. of the pillow: L. 35 x
W. 35 cm

4641099 white - blue

4641100 gray - white

Blanket dim.: W. 95 x L. 145
cm, dim. of the pillow: L. 35 x
W. 35 cm

4641108 white - blue

4641109 gray - white

4. Gingerbread pillow with a name

Dim.: L. 35 x W. 35 cm

4641102 white - blue

4641103 gray - white



While ordering a pillow send us name of the child and we'll embroider it for you!

BED WITH MATTRESS

Bed made of plywood, mattress made of foam trimmed with polyester.



Mattress fits into Sleepyhead bed. Available in separate sales.

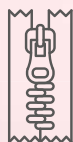

1. Bed Sleepyhead

Total size: L. 136 x W. 62 x H. 15 cm, mattress size: L. 130 x W. 60 x H. 8 cm

4520100

2. Mattress for bed Sleepyhead

Dim.: L. 130 x W. 60 x H. 8 cm

4641089

FOAM BED

Bed made of foam, trimmed with artificial leather.



Security provides Oeko-Tex certificate

NEW



beds and beddings



BOTTOM FASTENED WITH VELCRO

Foam bed with a mattress
Dim.: L. 137 x W. 77 x H. 25 cm

4641347



Set of bedding Parrots
Blanket dim.: W. 95 x L. 120 cm, dim. of the pillow:
L. 55 x W. 38 cm

4641350



Platform for Foam bed
Made of plywood. Dim.: L. 139 x W. 74 x H. 5 cm

DEN0005

MATTRESSES AND CABINETS

Body made of maple chipboard, doors made of lacquered MDF.



Mattresses filled with foam. One side covered with artificial leather, the other with strong cotton drill fabric.

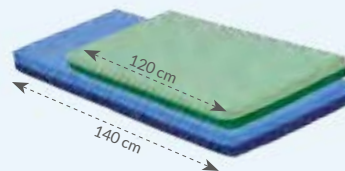

Nursery mattress

Dim.: L. 120 x W. 55 x H. 8 cm

4641061 Light green/green

4641062 Light blue/blue

Pre-school mattress

Dim.: L. 140 x W. 55 x H. 8 cm

4641063 Light green/green

4641064 Light blue/blue



Cabinet for 10 short mattresses and bedding

Dim.: H. 138 x W. 176 x D. 60 cm

6512589EX

Cabinet for 10 long mattresses and bedding

Dim.: H. 158 x W. 178 x D. 60 cm

6512591EX



Door to the cabinet for 10 short mattresses

3 pieces. Dim.: H. 128 x W. 58 x D. 1,8 cm

6512590EX

Door to the cabinet for 10 long mattresses

3 pieces. Dim.: H. 148 x W. 58 x D. 1,8 cm

6512592EX

Cabinet for mattresses and bedding is sold without door. Set of the door is sold separately.

DOUBLE-SIDED PRESCHOOL MATTRESSES



2 SIZES



length
120 cm

length
140 cm

DOUBLE-SIDED



Preschool mattress Nursery mattress

Dim.: W. 55 x H.8 cm

	L. 140 cm	L. 120 cm
green-gray	4641084	4641078
azure-gray	4641083	4641077
aquamarine-gray	4641082	4641076
pink-gray	4641081	4641075
yellow-gray	4641080	4641074
blue-gray	4641079	4641073



Security provides Oeko-Tex certificate

6 COLOURS

green-gray

azure-gray

aquamarine-gray

pink-gray

yellow-gray

blue-gray

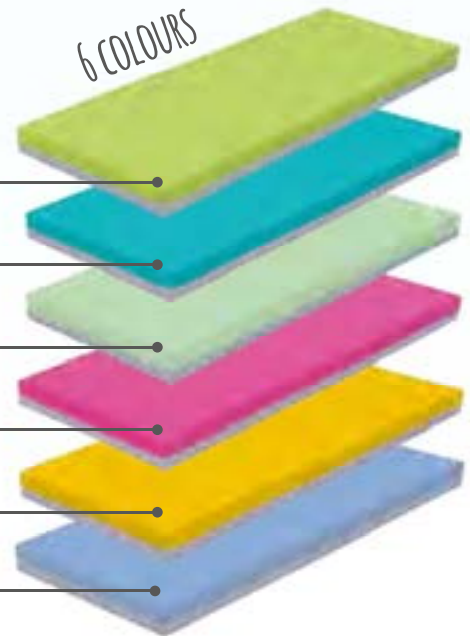

beds and beddings

FUNCTIONAL CABINETS WITH CURTAINS

Made of maple chipboard.



25 BEDS

24 SETS
OF BEDDING

1

2

3



CURTAINS MADE OF STRONG
COTTON FABRIC



SOLID, WOODEN STICK



Security provides
Oeko-Tex certificate

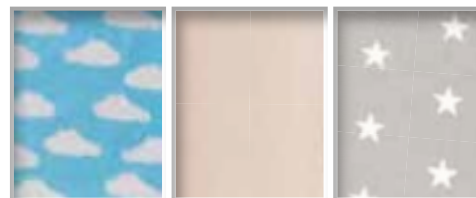

3 FABRIC PATTERNS TO CHOOSE

1. Storage unit for beds Mini

Dim.: H. 130,5 x W. 120 x D. 70 cm

4520405

Curtains for storage unit for beds Mini

4641224 [blue curtains](#)

4641110 [beige curtains](#)

4641225 [gray curtains](#)

2. Storage unit for beds Max

This chipboard made cabinet can store up to 25 beds with platform.

Dim.: H. 130 x W. 160 x D. 70 cm

4520403

Curtains for storage unit for beds Max

4641221 [blue curtains](#)

4641091 [beige curtains](#)

4641222 [gray curtains](#)

3. Storage unit for bedinnen

Dim.: H. 150 x W. 182 x D. 45 cm

4520404

Curtains for storage unit for bedinnen

4641227 [blue curtains](#)

4641090 [beige curtains](#)

4641228 [gray curtains](#)

Body made of maple chipboard,
doors made of lacquered MDF.



Wardrobe for bedding and beds
Dim.: H. 194 x W. 150 x D. 62 cm

6512458EX



solid construction
ensures safe use



holes for air circulation
between the shelves



hinges guarantee silent
closing of doors

WARDROBES FOR BEDDING

beds and beddings

Lockable wardrobe for bedding

The functional wardrobe for bedding storage.
Includes 25 compartments each containing a set
of children's' bedding and facilitating the storage of
their personal belongings.

The holes in the door ensure air circulation.
Dim.: H. 153 x W. 187 x D. 40 cm

6512316



Sport accessories

bestseller
on page 173





GYM TRIAL ACTIVE

sport accessories

▶ non-slip rubber on the feet of each ladder prevents from moving the benches while exercising



▶ stable benches can be fixed to wall gym ladders with bars of maximum diameter 44 mm

▶ solid fixing of the narrow and wide benches to the boxes



▶ two-stage blockade for safe and stable fixing of the benches

SERIES OF GYM BOXES ACTIVE

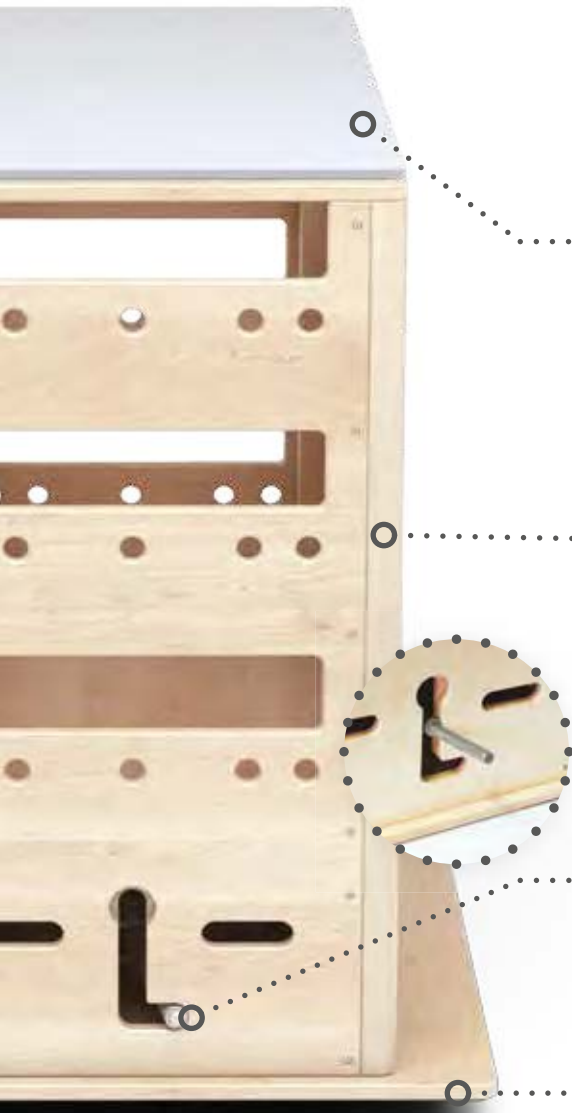

THE TOP OF GYM BOXES IS COVERED WITH FOAM TRIMMED WITH ARTIFICIAL LEATHER.



GYM BOXES ARE MADE OF BIRCH PLYWOOD, CORNERS OF BEECH WOOD AND RODS OF ASH WOOD.



HANDLE ON THE SIDE OF THE BOX MAKES THE WHEELS HIDE OR STICK OUT TO MOVE THE BOX EASILY (GYM BOX 6512447).



NON-SLIP RUBBER AT THE BOTTOM PREVENTS FROM SLIDING DURING EXERCISES.



Quality and safety guaranteed with certificates



Made of birch plywood, pillars are beech, poles are made of ash wood. The tops are covered with foam, trimmed with artificial leather.

The modular box consist of 4 modules. The height can be adjusted by removing the 2 modules in the middle. There are holes in the box to block the benches. The width of the holes is 41 and 66 cm



Each module box can be used as a separate element

Small gym box is only for sensory benches, p. 170-171



Large gym box Active

Dim.: H. 104 x W. 98 x D. 98 cm

6512426



Small gym box Active

Dim.: H. 75 x W. 70 x D. 70 cm

6512427



Platform to the gym boxes Active

Dim.: H. 8,5 x W. 98 x D. 98 cm

6512444

made of plywood



Platform equipped with wheels with blocade

WIDE, NARROW AND SENSORY BENCHES FIT INTO THE MODULAR AND LARGE BOX



Modular gym box Active

Dim.: H. 104 x W. 104 x D. 80 cm

6512425



Modular gym box Active on wheels

Dim.: H. 107 x W. 104 x D. 80 cm

6512446



Gym box Active on wheels

Dim.: H. 107 x W. 104 x D. 80 cm

6512447

safe mechanism for hiding wheels

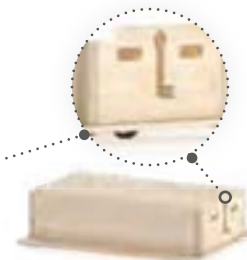

Mobile module to the modular gym box Active

Dim.: H. 27,5 x W. 104 x D. 80 cm

6512445

made of plywood

unavailable in Germany, Switzerland and Austria

GYMNASTIC LADDERS/ACTIVE

ladders made of 18 mm birch plywood,
two-stage blockades applied from both sides enable a solid and safe fixing to the gym boxes,
colourful reinforcing element and side elements made of 30 mm plywood,
rungs are made of ash wood durable for cracks,
anti-slip rubber on the bottom allows safe using on the floor and fixing them in
different configuration with boxes and wall ladders (with rungs of maximum diameter of 44 mm),
ladders fit into the large and modular box.



Quality and safety
guaranteed with
certificates

WIDE LADDERS



1

2

3

4

1. Wide slide Active

Dim.: H. 13 x L. 240 x W. 65 cm

6512434

2. Climbing net Active

Dim.: H. 17 x L. 240 x W. 63 cm

6512433

5. Narrow ladder Active

Dim.: H. 13 x L. 240 x W. 40 cm

6512429

6. Chicken ladder Active

Dim.: H. 10 x L. 240 x W. 35 cm

6512430

NARROW LADDERS



5

6

7

8

3. Roller slide Active

Dim.: H. 13 x L. 240 x W. 65 cm

6512432

7. Alternating ladder Active

Dim.: H. 9 x L. 240 x W. 36 cm

6512431

4. Wide ladder Active

Dim.: H. 13 x L. 240 x W. 65 cm

6512428

8. Narrow slide Active

Dim.: H. 13 x L. 240 x W. 40 cm

6512435

Sensory benches on p. 170 - 171

unavailable in Germany, Switzerland and Austria



A wide range of ladders, various kinds of gymnastic boxes, possibility to complete various combination with sensory benches makes every physical activity or rehabilitation more attractive. Thoughtful fixing system guarantees safe use. ACTIVE series support children motor development, enhances and organizes movement activities.



1. Snake - balance beam

Powder coating protects against splashes.
Dim.: L. 240 x W. 35 cm, pipe dia. 5 cm

6512442

2. Simple balance beam

Made of birch plywood.
Dim.: H. 9 x L. 240 x W. 35 cm

6512443

3. Sensory feet - sensory bench

Sensory feet made of a flexible plastic material,
with different sizes knobs. Dim.: H. 8 x L. 240 x
W. 35 cm

6512441

4. Hedgehog - sensory bench

The rubber mat with knobs for feet massage.
Dim.: H. 8 x L. 240 x W. 35 cm

6512439

green

6512439B

colourful

6. Platforms - sensory bench

3 sizes platforms at different heights, clear colours
and different textures of the cover. Dim.: H. 16 x L.
240 x W. 35 cm

6512437

7. Coloured benches - sensory bench

Grooves on benches, painted with ecological
paints, placed up-down and left-right in relation to
the bench. Dim.: H. 18 x L. 240 x W. 35 cm

6512438



Quality and safety
guaranteed with
certificates

5. Tactile ABC - sensory bench

Sections of length 23 cm are covered with
materials of different textures.
Dim.: H. 8 x L. 240 x W. 35 cm

6512440

8. Patterns - sensory bench

Various grooves made in birch plywood, pins made
of beech wood.
Dim.: H. 8 x L. 240 x W. 35 cm

6512436



1. Snake - balance beam



2. Simple balance beam



3. Sensory feet - sensory bench



4. Hedgehog - sensory bench

- ▶ various textures on the surface of the benches stimulate the senses, feet
- ▶ receptors, stimulate their muscles,
- ▶ made of 15 mm birch plywood,
- ▶ they have a two-stage blockade for safe and stable fixing the benches to gym boxes,



5. Tactile ABC - sensory bench



6. Platforms - sensory bench



7. Coloured benches - sensory bench



8. Patterns - sensory bench

- ▶ non-slip rubber on the feet of each bench makes it possible to use them on the floor, or fit in different combinations to the boxes,
- ▶ sensory benches fit into a small and modular box.

 Ladders, benches, gym chests, sports equipment - all these elements are the basis of a well-equipped gym, where classes are held for physical education at the highest level. Certificates confirming compliance with the standards of our equipment guarantee the safety for users.



1. Kindergarten ladder
Dim.: H. 208 x W. 62 x D. 8 cm

4620001

2. Ladder

A 4620003	single -	Dim.: H. 244 x W. 92 x D. 12 cm
	double -	Dim.: H. 244 x W. 181 x D. 12 cm

3. Small ladder

Small ladder which can be mounted in every hall. Gives possibility to transfer some exercises to small group halls without the need for using a gym.
Dim.: H 150 x W 62 x D 8 cm

4525555

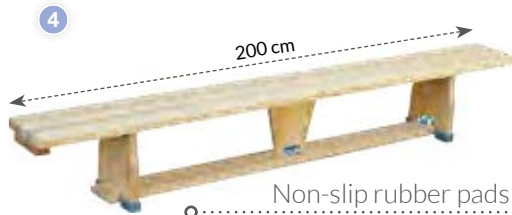

4. Gym bench

A 4620005	Dim.: L. 2 m x H. 30 cm
B 4620006	Dim.: L. 3 m x H. 30 cm

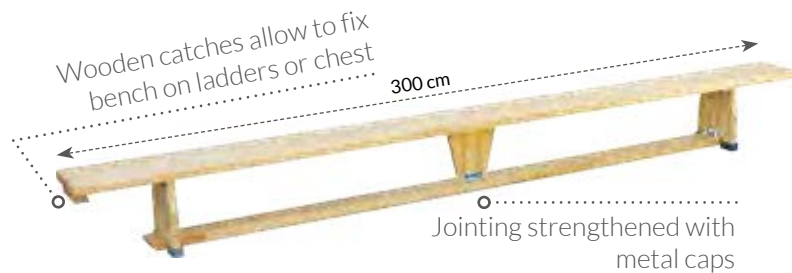

BENCHES MADE OF WOOD ARE EXTREMELY DURABLE!



COMPLETELY SAFE ROPE
FIXING TO THE PLYWOOD



STRONG AND DURABLE ROPE
CLIMBING



ERGONOMIC CLIMBING
WALL HANDLES



Multiclimber

Multiclimber is equipped with a kind of thin, smooth rod, a rope with knots and ladders: horizontal, alternating and a rope that enables children to hang and to climb in many ways. This device can only be used inside the building. Base and the top made of birch plywood, construction elements made of pine wood, beech sticks, elements coated with ecological lacquer, anti-slip rubber attached to the bottom of the base. Mounting material included. Dim.: dia. of base 130 cm, length of the side 114 cm, height 183 cm

4520306W2

MULTICLIMBER



Quality and safety
guaranteed with
certificates



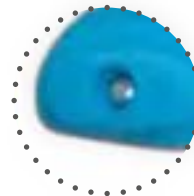

INTERESTINGLY ERGONOMIC HANDLES!

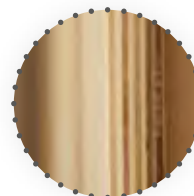

DURABLE PLYWOOD!

Climbing wall

Wall panel for strength exercises which is equipped with steps for feet and hands like holes and stones. Exercising with climbing wall trains arms and legs. All needed parts are included.

Dim.: H. 200 x W. 125 x D. 7 cm

4520318



BRIDGE MADE OF DURABLE PLYWOOD!



Wooden bridge-cradle

Maximum load 80 kg.
Dim.: W. 84 x D. 42 x H. 14,5 cm

4520321

SHELVING FOR GYMNASTICS

Made of lacquered plywood, contains strong wheels.

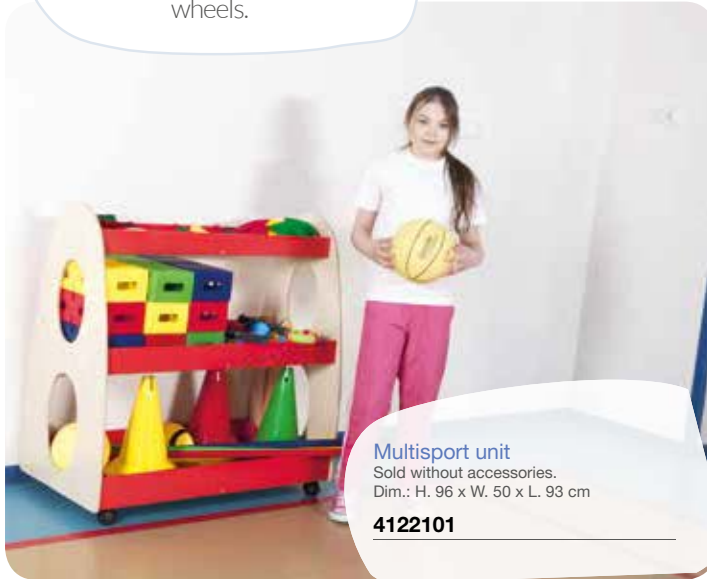

Multisport unit
Sold without accessories.
Dim.: H. 96 x W. 50 x L. 93 cm
4122101

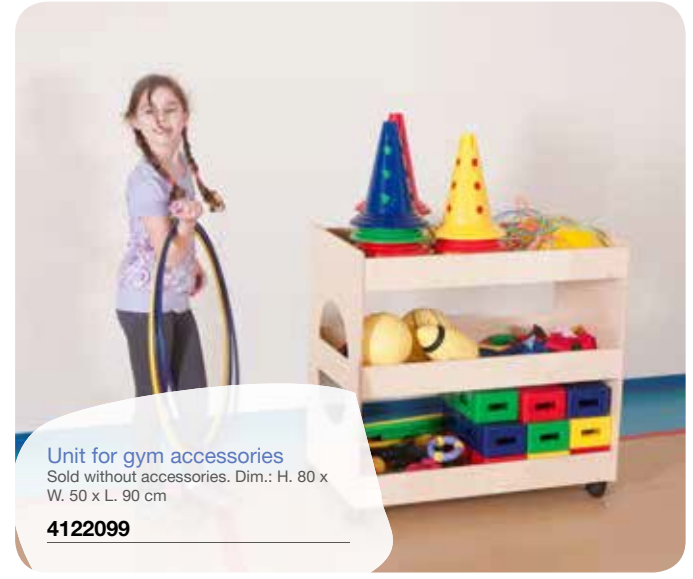

Unit for gym accessories
Sold without accessories. Dim.: H. 80 x
W. 50 x L. 90 cm
4122099



Solid wooden construction provides high strength! The elastic cord keeps the ball, and allows easy access.

Wheels provide mobility!

Basket for balls
Basket for balls with unusual capacity.
Dim.: 75 x 75 x 127 cm

4520230



sport accessories

The player's task is to hit a ball into the cavity located on the opponent's side and at the same time prevent him from hitting the ball in his own. You have to maneuver the mat in such a way that the ball jumps as often as possible into the competitor's field.

Made of material with strong weave, and therefore does not risk tearing it during the game.

BESTSELLER

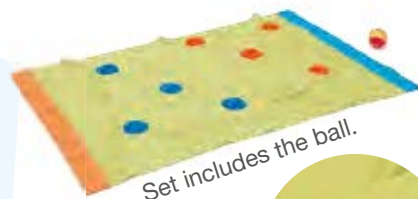

Set includes the ball.



Defeat the competitor - mat
Dim.: L. 180 x W. 110 cm

4640859

SCHOOL BAGS



NEW

1. School bags with granules

Set of 6 pcs, dim.: 10 x 10 cm

6305601

2. Bags with granules Pyramid

6 pcs, dim.: 6 x 6 x 6 cm

6305600

3. Bags with gravel

Set of 10 bags, dim.: 10 x 11cm

6306694

4. Bags with gravel pyramid

Set of 10 bags, dim.: 8 x 8 x 8 cm

6306695

Jumping trousers ideal for activities, an excellent way to sports competition both in the fresh air and in the gym. Perfect for integration games. Trousers are connected from one side, so that the cooperation of children is essential. They are made of durable material, and have rubber straps.

GREAT FUN WITH JUMPING TROUSERS!



Jumping trousers

Size S: dim.: D. 160 x H. 90 cm
Size M: dim.: 180 x H. 120 cm

4640485	S blue
4640628	M blue
4640656	S green
4640658	M green
4640655	S orange
4640657	M orange

2 SIZES

S M

3 COLOURS

BLUE

GREEN

ORANGE



sport accessories



Jumping bags

Big, colourful and durable bags for jumping. Recommended for movement, fun and for sport competitions. Easy and comfortable in handling, incredibly durable. Practical handles ensure safe fun. Dim.: 45 x 60 cm 6 pcs.

4394193

6 PCS.



Mattresses & sensory

bestseller
on page 181

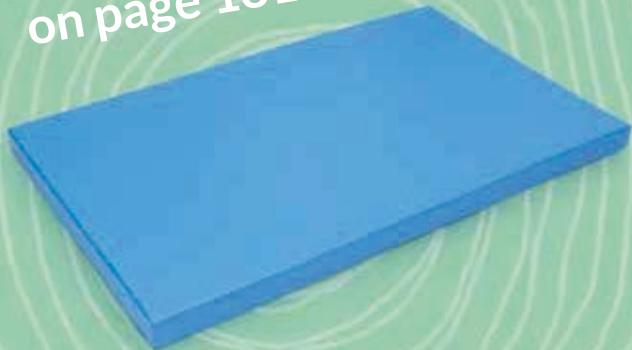

COLOURED WALL PROTECTIVE MATTRESSES

Mattresses filled with foam, trimmed with artificial leather.



mattresses & sensory

Wall protective mattress is a compulsory protective element ensuring safety while performing various exercises. Effectively protects the wall so that children can exercise with safety. Soft, filled with polyurethane foam perfectly amortizes contact with the wall. Easy to keep clean.

1. Protective mattress

Dim.: L. 120 x W. 100 x H. 4 cm

4640698	orange
4640699	red
4640700	pink
4640701	light blue
4640702	light green
4640703	dark green
4640704	grey

2. Wall protective mattress

Soft mattress for hanging on the wall improves kids self-confidence while exercising. Colourful and perfect protection for gym halls. Elastic material amortises every dangerous contact with wall. It covers large area of hard surface.

Dim.: L. 200 x W. 120 x H. 4 cm. 1 pcs.

4521110



EXTRA BELT ALLOWS FIXING THE MATTRESS TO THE WALL





Filled with foam, trimmed with artificial leather.

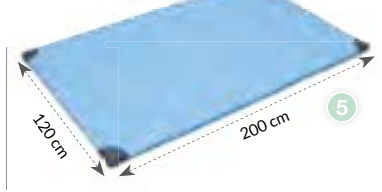
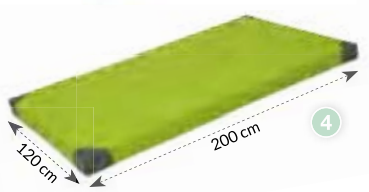
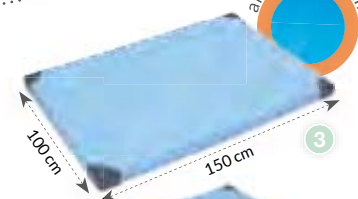
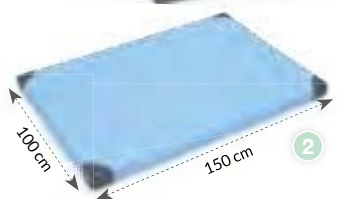

1. Mattress 400

Large surface, thick mattress, trimmed by mesh facilitating the escape of air at a rapid pressure. Mattress flexibly depreciated while jumping.
Dim.: L. 200 x D. 120 x H. 20 cm

4521530

2. Rehabilitation mattress R90

Very hard matrs made of special foam from granulate. Dim: W. 100 x H. 8 x L. 150 cm

4521511

3. School mattress

Dim.: W. 100 x H. 8 x L. 150 cm

4521510

4. Sports mattress

Dim.: L. 200 x W. 120 x H. 10 cm

4640975

5. Large school mattress made of hard foam

Dim.: L. 200 x W. 120 x H. 5 cm

4521520



Security provides
Oeko-Tex certificate



- foam resistant to deformation
- trimmed with durable and nonflammable artificial leather
- slipcovers are precisely fitted to the shape of a particular foam

1. Folded mattress 3

Dim.: W. 70 x H. 4 x L. 3 x 60 cm

45210253

2. Large mattress 300

Dim.: W. 120 x H. 10 x L. 200 cm

4521150

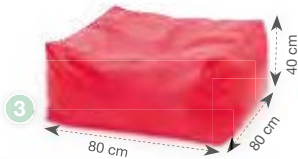
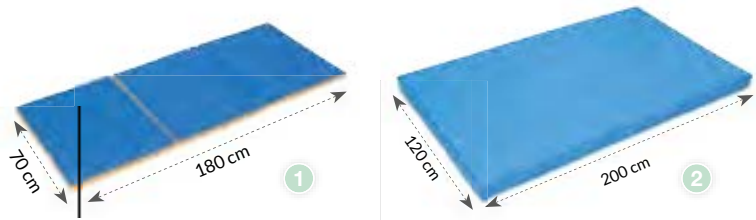

3. Large pouf with granulate

Dim.: L. 80 x W. 80 x H. 40 cm

4521345

4. Mattress with granulate

Dim.: W. 120 x H. 20 x L. 200 cm

4521343

Filled with granulate and wrenched foam mix, trimmed with artificial leather.



SENSORY SET I



Set of low, soft blocks ideal for rehabilitation and relaxation. Variety of shapes, each with different filling: with silicone, buckwheat, polyurethane foam, pea or granulate.

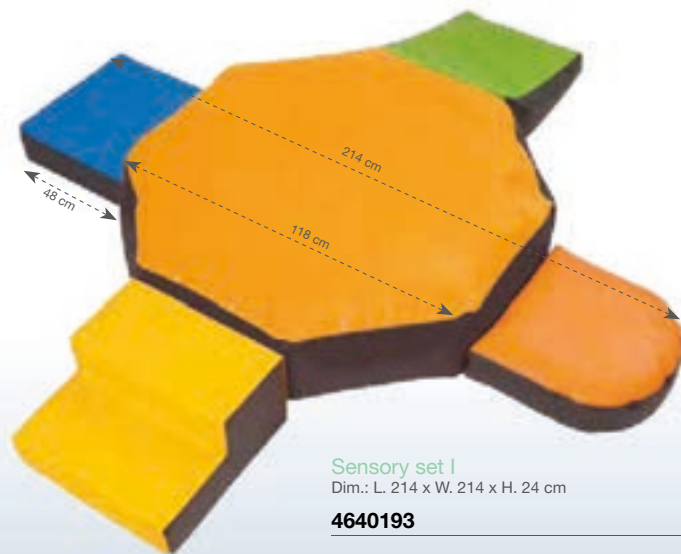

Sensory set I
Dim.: L. 214 x W. 214 x H. 24 cm

4640193

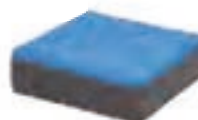

Filled with foam and
2 cm layer of peas
Dim.: 48 x 48 x 15 cm



Filled with buckwheat
Dim.: 26 x 48 x 48 cm



Filled with mix of styrofoam granulate and
wrenched foam parts.
Dim.: 24 x 118 x 118 cm



Filled with foam
Dim.: 24 x 48 x 48 cm



Filled with silicone
Dim.: 15 x 48 x 48 cm

SENSORY CROCODILE

Great fun for kids who love the variety of obstacles during playing!

Inside each element there is a polyurethane foam, while the two central elements of the crocodile have an additional layer filled with grains of peas.



Security provides
Oeko-Tex certificate



Sensory crocodile
Dim.: L. 192 x H. 35 x W. 48 cm

4640560

mattresses & sensory

FILLING:

1

GRANULATE



2

WHEAT



3

SILICONE



4

FOAM



5

PEA



6

BUCKWHEAT



7

CANOLA



SENSORY



ANTI-SLIP



MANUAL SKILLS DEVELOPMENT



LEARNING TO FASTEN VARIOUS
FASTENERS

•
FLOWER PETALS HAVE DIFFERENT FILLINGS:
STYROFOAM BALLS, RUSTLING FOIL, FLUFFY
FLEECE AND BUCKWHEAT HULLS, ALSO AFFECT
THE SENSE OF TOUCH AND HEARING

•
CAN BE USED AS A TABLE OR A SEAT

•
PLAYING WITH VARIOUS FASTENERS
DEVELOPS MOTOR SKILLS AND DEXTERITY

Manipulation and sensory flower
Dim.: L. 45 x W. 45 x H. 30 cm

4640855

Foam pouf trimmed with: artificial
leather, cotton and suede.



BUCKLE



ZIPPER



STUD



1st side

Manipulating House

Handling cube, excellent with the assistance of motor skills exercise. Fun zippers, laces, snaps, buckles will help children learn the skills they need while dressing. Dim.: L. 40 x W. 30 x H. 51 cm

4640352



2nd side



3rd side



4th side



WORLD OF TOUCH BOOK

The booklet in which each page has a different texture and colour encourages children to observe and experience the sense of touch. The toddler gets acquainted with the characteristics of various textures through touch and sight. Book cards are loosely connected so they can be easily unlaced and spread out to create a sensory path.

4641182



Pools

bestseller
on page 189



Made of foam, trimmed with artificial leather.

Suggested ball amount: 500 pcs.



playpen
with cover



Playpen Meadow

Dim.: Dia. 105 x H. 30 cm. Balls not included.

4640345

Cover for playpen Meadow

Blue.

4640966

Made of foam, trimmed with artificial leather.

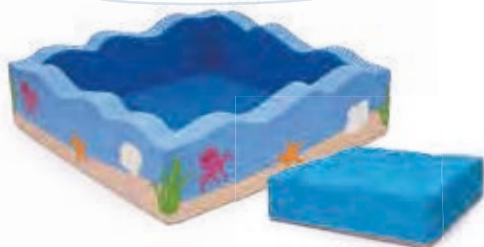

playpen
with cover



Playpen Ocean

Dim.: L. 124 x W. 124 x H. 35 cm. Balls not included.

4640351

Cover for playpen Ocean

Blue.

4640967

FILLING PLAYPEN WITH BALLS
YOU CAN USE IT AS A POOL!



Made of foam, trimmed with artificial leather.

KIDS LOVE POOLS WITH BALLS!



Suggested balls amount 2000 pcs.

Pool corner Balloons

Dim.: L. 160 x W. 160 x H. 40 cm. Balls not included.

4640378



ANTI-SLIP

Balls dia. 7 cm
500 pcs.

4540009	white
6306298	yellow



playpen
with cover

1. Rainbow pool

Balls not included. Dim.: W. 120 x D.120 x H. 30 cm

4640407

2. Cover for Rainbow pool

Blue.

4640965



3. Corner ball pit green

External side dim.: L. 160 x W. 160 x H. 40 cm,
arch dim.: 260 cm, wall thickness 20 cm. Balls not
included.

4529007



Suggested balls amount 2000 pcs.

pools

4. Square ball pit red

External side dim.: L. 140 x W. 140 x 41 cm, wall
thickness 20 cm. Balls not included.

4529008



Suggested balls amount 2000 pcs.

pool sold without balls



Corner ball pit Fish

External side dim.: L. 205 x 205 cm, arch dim.: 330 cm, wall thickness 20 cm. Cover made of artificial leather. Suggested no of balls 3000 pcs.

4529011



Balls dia. 7 cm

6306298	yellow
6306299	orange
6306300	red
6306301	blue
6306302	green
4540007	colour mix



Playpen with mattress for blocks

Dim.: dia. 100 x H. 30 cm

4640953



Made of foam, trimmed with artificial leather.

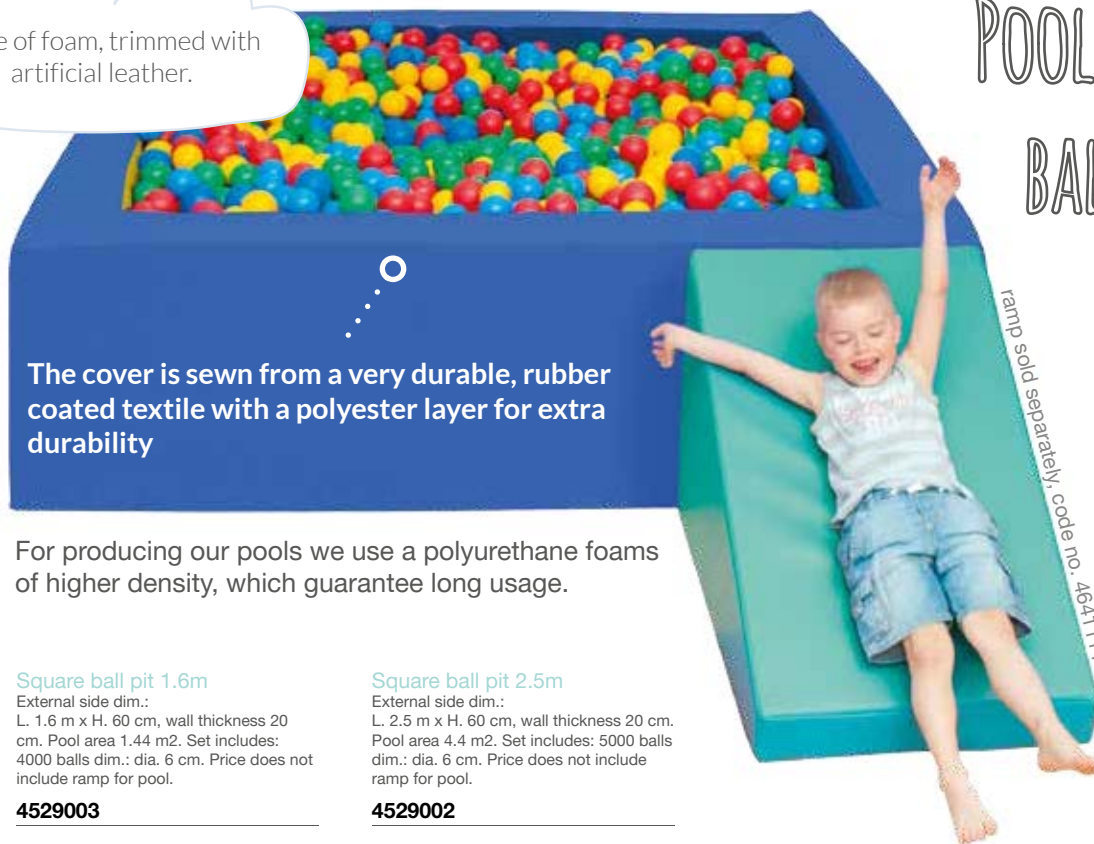

POOL WITH
BALLS!

The cover is sewn from a very durable, rubber coated textile with a polyester layer for extra durability

For producing our pools we use a polyurethane foams of higher density, which guarantee long usage.

Square ball pit 1.6m

External side dim.:
L. 1.6 m x H. 60 cm, wall thickness 20 cm. Pool area 1.44 m². Set includes: 4000 balls dim.: dia. 6 cm. Price does not include ramp for pool.

4529003

Square ball pit 2.5m

External side dim.:
L. 2.5 m x H. 60 cm, wall thickness 20 cm. Pool area 4.4 m². Set includes: 5000 balls dim.: dia. 6 cm. Price does not include ramp for pool.

4529002

ramp sold separately, code no. 4641111

pools

Foam games

bestseller
on page 196



ARRANGE COLOURS

Mattress and poufs are made of foam and trimmed with artificial leather so it is easy to keep them clean. Soft pawns can be also used as comfortable poufs.

Set consists of: 6 poufs and 12 work cards.

Made of foam, trimmed with artificial leather.



foam games

Arrange colours

Set of a mattress, 6 pouffes and 12 activity cards.
The aim of the game is to reproduce to pattern from the card. Dim.: L. 115 x V.80 x H. 3 cm.

4641135

THERE ARE 6 GRAY CIRCLES ON THE MATTRESS. THE AIM OF THE GAME IS TO FILL THEM WITH THE POUFS SO THEY LOOK LIKE ON THE PATTERN CARD.



SHIELD MASTER

Made of foam, trimmed with artificial leather.

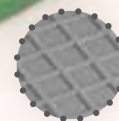
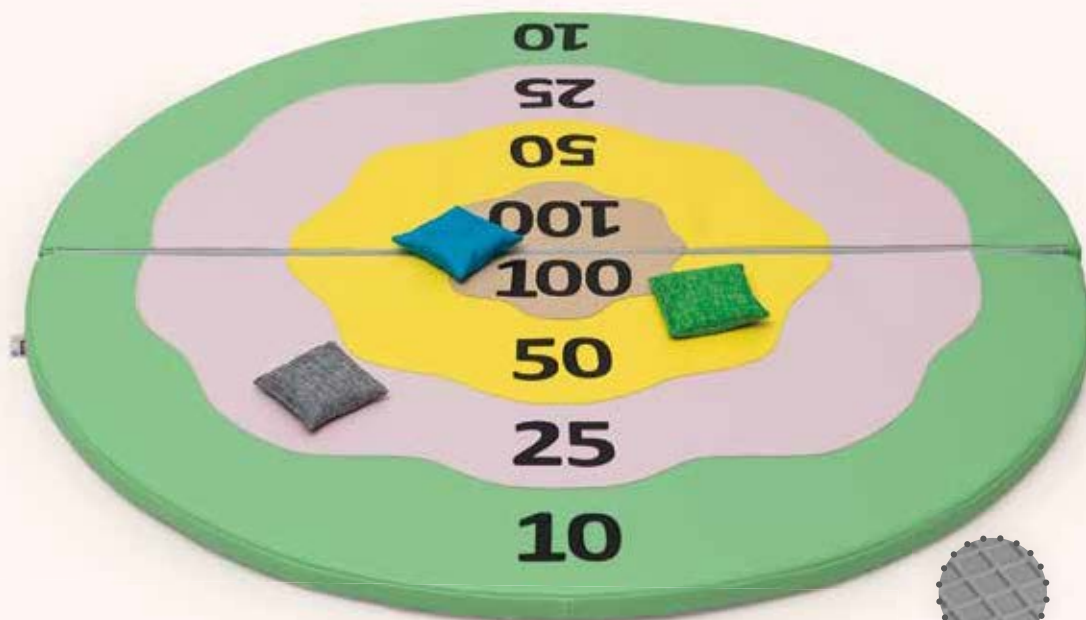

ANTI-SLIP

COVER WITH A POCKET FOR THE BAGS INCLUDED

3 BAGS FILLED WITH PEAS



NEW

Shield master

The game consists of the round mattress and 3 bags filled with peas. The aim of the game is to gain the highest score while throwing. Mattress can be folded in half. Cover with a pocket for the bags included.

Anti-slip base.

Dim. of the mattress: Dia. 110 x H. 3 cm

4641245

Made of foam, trimmed with artificial leather.



foam games

NEW



Figlo foam blocks

Set of 18 foam blocks which form 9 various shapes, 3 squares, 3 circles and 3 hexagons. The aim of the game is to find pieces that match.

Dim. of the smallest element: 30 x 15 x 10 cm, the biggest one: 30 x 20 x 10 cm

4641258



MAXI DOMINO

Made of foam, trimmed with artificial leather.



ANTI-SLIP



Maxi domino

28 elements of dim.: L. 40 x W. 20 x H. 3 cm

4640733

Cover to Domino set

Gray.

4640988



TIC TAC TOE MAXI

We play with simplicity and form! Mental game, to which we added element of motor skills. To block an opponent at creating a single line of his cubes should involve not only the mind but the whole body. If necessary, all elements of the game perfectly serve as seats. Set includes: mattress and 10 cubes dim.: 30 x 30 cm



Tic Tac Toe maxi

Mattress dim.: L. 90 x W. 90 x H. 3 cm

4640292

Cover for Tic Tac Toe set

Gray.

4640994



Made of foam, trimmed with artificial leather.

FOAM MEMORY GAME

NEW



A NEW VERSION OF MEMORY GAME

24 big, soft elements filled with foam can be used as a set of seats for the group of children or as a memory game. There is a shape sewn on one side of the foam square (e.g. apple, flower, car, cloud) while the other one is plain. At the beginning of the game, all the elements have to be turned with the plain side up and put aside. Children look for a pair with the same picture. They can unveil only 2 pieces at the time. If they are lucky, they keep the pair, if not, they put the elements back in the same place. The one who gets most pairs, wins.

Foam memory game

Big size memory game. On one side of foam brick, there are elements sewn on, the other side is plain. Among 24 elements there are 12 pairs with the same picture. The aim of the game is to find all pairs. Dim.: L. 30 x W. 30 x H.3 cm

4641143

Cover to memory game

Gray

4641179



Foam shapes, XXL blocks

bestseller
on page 200



Made of foam, trimmed with artificial leather.

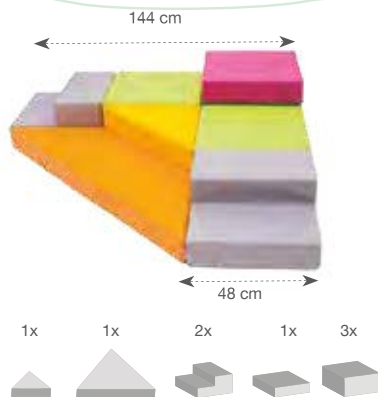

Megaform II

The set includes:

- stair 24 x 24 x 48 cm - 2 pcs.,
- triangle 12 x 96 x 96 cm - 1 pc.,
- triangle small 12 x 48 x 48 cm - 1 pc.,
- cube wide 24 x 48 x 48 cm - 3 pcs.,
- narrow cube 12 x 48 x 48 cm - 1 pc.

4640232

FOAMS FOR TODDLERS



foam shapes, XXL blocks

Set of small foam shapes suitable for small children or nursery users. Can be putted together in a various combination. They can be used as single element to overcome „an independent object”, or configured in any way, depending on the predispositions. Climbing on and overcoming various obstacle courses have a positive impact on toddlers' motor skills development.

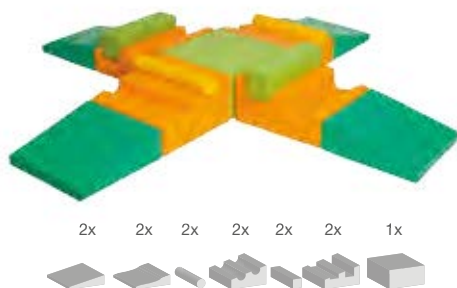

Relax tower set

13 foam shapes. Dim.: W. 250 x D. 250 x H. 25 cm

4640275



PEACOCK EYE



Made of foam, trimmed with artificial leather.



Peacock eye

Safe mirrors, where child can see its own reflection.

Set contents of 4 elements dim.:

L. 25 x W. 25 x H. 6 cm,

L. 31 x W. 31 x H. 10 cm,

L. 45 x W. 45 x H. 15 cm,

L. 60 x W. 60 x H. 20 cm,

set dim.: 135 x 60 x 20 cm

4640198

LOW SET FOR SMALL CHILDREN

7 PCS.



Made of foam, trimmed with artificial leather.

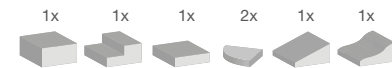

Island soft foam set

7 pcs. Dim.: H. 24 x W. 145 x D. 145 cm

4521145

FOAM STONES

Made of foam, trimmed with artificial leather.

Different heights of foam, allow you to arrange various paths to create obstacle course for children.

Set consists of:



Foam stones

4640904	grey	Dim.: L. 78 x W. 61 x H. 42 cm
4640903	light green	Dim.: L. 78 x W. 61 x H. 28 cm
4640902	pink	Dim.: L. 78 x W. 61 x H. 21 cm
4640901	beige	Dim.: L. 39 x W. 30 x H. 17,5 cm
4640900	brown	Dim.: L. 39 x W. 30 x H. 7 cm
4640899	turquoise	Dim.: L. 39 x W. 30 x H. 3,5 cm
4640898	Foam stones set	6 pcs



foam shapes, XXL blocks

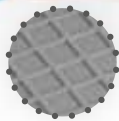

ANTI-SLIP

Buying single pieces allows you to create different paths!



UNCONVENTIONAL CLIMBING SET!

BIG SET OF DIA. 290 CM

6 DIFFERENT ENTRANCES!



Made of foam, trimmed with artificial leather.

- different colours of individual blocks
- a variety of ascent / descent from the tower
- defeating various difficulties to achieve the goal
- a soft landing thanks to triangular mattresses
- the ability to use individual building blocks to create an obstacle course

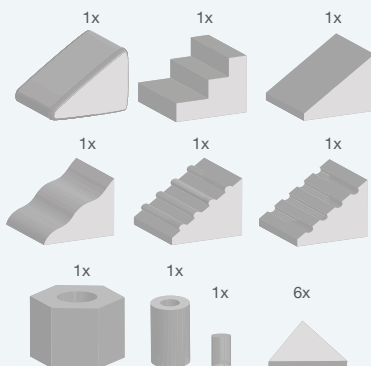

Tower with hole soft foam set

Set contains:

hexagon Max with holes
concave stairs half round
convex stairs half round
straight stairs
wave
big ramp
ramp with granulate
small tire
short roller
triangle

L. 60 x W. 120 x H. 60 cm
W. 60 x H. 60 x L. 90 cm
W. 60 x H. 60 x L. 90 cm
W. 60 x H. 60 x D. 90 cm
W. 60 x H. 60 x L. 90 cm
W. 60 x H. 60 x L. 90 cm
W. 60 x H. 60 x L. 90 cm
Dia. 60 x Dia. inner 30 x W. 30 cm
Dia. 30 x L. 30 cm
W. 90 x H. 10 x L. 90 cm
Dim.: H. 120 x Dia. 290 cm

4521009

Unusual climbing on the colourful, soft steps guarantees a lot of fun! Climb, fall down, climb again! With our steps no fall is dangerous.

JIGSAW PUZZLE

NEW

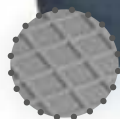

ANTI-SLIP

foam shapes, XXL blocks



artificial leather



tornado

Jigsaw puzzle leatherette

5 elements of dim.: L.. 76 x W. 50 x H. 20 cm, L. 155 x W. 148 x H. 30 cm, L. 71 x W. 47 x H. 40 cm, L. 80 x W. 93 x H. 50 cm, L. 114 x W. 50 x H. 10 cm

4640601

Jigsaw puzzle tornado

5 elements of dim.: L.. 76 x W. 50 x H. 20 cm, L. 155 x W. 148 x H. 30 cm, L. 71 x W. 47 x H. 40 cm, L. 80 x W. 93 x H. 50 cm, L. 114 x W. 50 x H. 10 cm

4641333

ALL DEPENDS ON CHILD'S
IMAGINATION



JOLLYHEAP IS:

- a European product, made of durable and safe materials,
- hand made,
- have a CE certificate,
- soft, doesn't have a sharp edges,
- large blocks (dim.: 12 x 12 x 12 cm), 70 pcs of square blocks, 30 pcs of triangles
- every block includes strong neodymium magnets with a 10 years guaranty,
- washable,
- multifunctional (toy, furniture, mattress, etc.)
- age limit: 1 - 99



Jolly Heap magnetic blocks

100 pcs.

6306193	lime - pink
6306194	red - pink
6306195	gray - turquoise
6306196	gray - pink
6306197	red - dark blue
6306206	beige - graphite

Made of foam, trimmed with artificial leather.



Super brick soft foam 10 pcs.

A colourful set of 10 rectangular bricks, whose strength lies in its simplicity. They are light and safe and the possibility of fun - virtually unlimited. Perfect for children who like to play in building. Various colours stimulate thinking and encourage the creation of multiple structures.

Dim.: L. 24 x W. 12 x H. 6 cm

4521060

SUPER BRICK SOFT FOAM



Tested for harmful substances
according to Oeko-Tex® Standard 100
IW 00113 IW

Security provides
Oeko-Tex certificate



Made of foam, trimmed with artificial leather.



Foam blocks mix

9 foam shapes. The smallest block dim.: 22 x 20 x 49 x 30 cm, the largest block dim.: 43 x 49 x 30 cm

4640430

MIX OF FOAM BLOCKS



foam shapes, XXL blocks

SMALL DICES FOR FUN!

Made of foam, trimmed with artificial leather.



COMPLETELY
HIDDEN ZIP

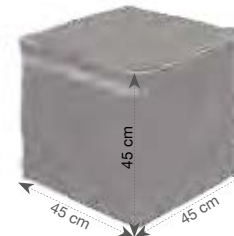

The set of 27 cubes

Small cubes in 9 colours can be divided into sets. Precisely measured cubes are light and even small children can easily grab them. Carrying case is included in the set.

4641304

SET FOR CREATIVE LEARNING OF NUMBERS

CLEAR DIGITS BIG
AND LIGHT CUBES

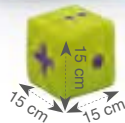

Made of foam, trimmed with artificial leather.

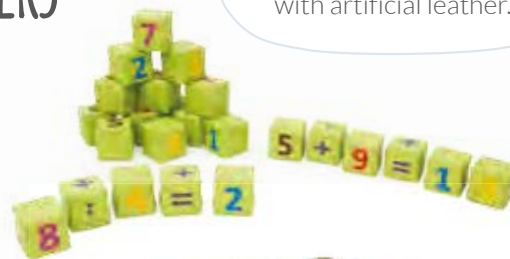

Numbers - small cubes

24 pcs in a bag.

4640317

Elements filled with foam,
trimmed with artificial leather.

NEW

FOAM BLOCKS BRAIN TEASER

consists of 7 foam shapes covered with easy to clean mediatap. Think, communicate with your group members and put together all cube`s elements.

2 sizes: maxi & mini

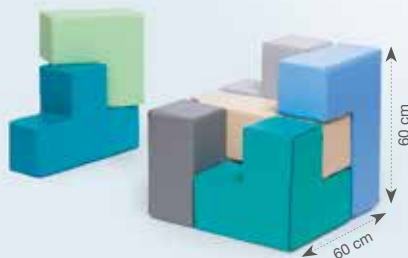
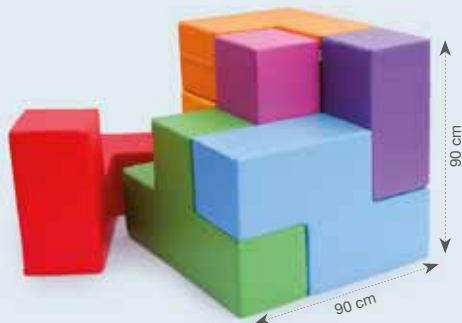

1. Build a cube set

Colourful cube dim.: H. 90 x W. 90 x D. 90 cm

4521320



2. Mini build a cube set

Dim.: H. 60 x W. 60 x L. 60 cm

4641121

3. Mini build a cube set in black and red

Dim.: H. 60 x W. 60 x L. 60 cm

4641120



Think, communicate with your group members and combine all cube`s elements.

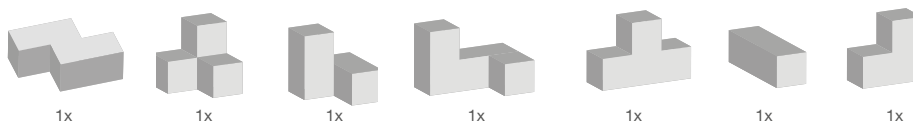

e-mail: export@novumgrom.com



NOVUM

207 <

MIRROR REFLECTION HOUSE

Made of foam, trimmed with artificial leather.

CIRCULAR ELEMENTS HAVE SAFE MIRROR ON ONE OF THE SIDE
ON ONE OF THE SIDE



THE ELEMENTS ARE CONNECTED WITH VELCRO SO YOU CAN BUILD NOT ONLY A CUBE BUT ALSO A PATH OR A MAT OUT OF THEM.



Mirror reflection house

The set consists of: 5 walls with velcro tape, 5 elements with safe mirror, mattress - floor. The dimensions of folded: L. 120 x W. 100 x H. 110 cm

4640989

Made of foam, trimmed
with artificial leather.

SMALL FOAM BLOCKS



Set of small foam blocks

33 foam blocks:

short cylinder
medium cylinder
half tire
long cylinder
long beam
mini bridge
roof
mini roof
long triangle
medium triangle
short triangle
short roller
medium roller
half roller
long roller

dim.: L. 20 x W. 20 x H. 20 cm, 4 pcs.
dim.: L. 40 x W. 20 x H. 20 cm, 1 pc
dim.: L. 30 x W. 30 x H. 15 cm, 2 pcs.
dim.: L. 80 x W. 20 x H. 20 cm, 2 pcs.
dim.: L. 80 x W. 20 x H. 10 cm, 2 pcs.
dim.: L. 60 x W. 40 x H. 20 cm, 2 pcs.
dim.: L. 76 x W. 42 x H. 20 cm, 1 pc
dim.: L. 60 x W. 26 x H. 20 cm, 2 pcs.
dim.: L. 60 x W. 20 x H. 17 cm, 2 pcs.
dim.: L. 40 x W. 20 x H. 17 cm, 2 pcs.
dim.: L. 20 x W. 20 x H. 17 cm, 4 pcs.
dim.: L. 20 x W. 20 x H. 20 cm, 2 pcs.
dim.: L. 20 x W. 20 x H. 40 cm, 3 pcs.
dim.: L. 80 x W. 20 x H. 10 cm, 2 pcs.
dim.: L. 20 x W. 20 x H. 80 cm, 2 pcs.

4640836

Cover for small foam blocks set

Dark blue. Dim.: L. 120 x W. 80 x H. 70 cm

4640905



- INDIVIDUAL MODULES TO SIT ON
- POSSIBILITY TO CREATE VARIOUS OBSTACLES THAT KIDS LOVE TO OVERCOME

foam shapes, XXL blocks

SOFT FOAM SET I

Made of foam, trimmed with artificial leather.

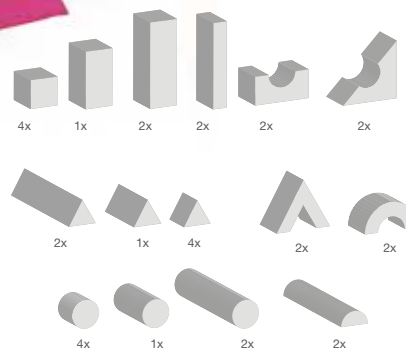

Soft foam set I

long roller	dim.: dia. 30 x 120 cm	2 pcs.
medium roller	dim.: dia. 30 x 60 cm	1 pcs.
small roller	dim.: dia. 30 x 30 cm	4 pcs.
long beam	dim.: 30 x 30 x 120 cm	2 pcs.
small beam	dim.: 30 x 30 x 60 cm	1 pcs.
small cube	dim.: 30 x 30 x 30 cm	4 pcs.
long triangle	dim.: 30 x 30 x 90 cm	2 pcs.
medium triangle	dim.: 30 x 30 x 60 cm	1 pcs.
short triangle	dim.: 30 x 30 x 30 cm	4 pcs.
half roller	dim.: dia. 30 x 120 cm	2 pcs.
cuboids	dim.: 30 x 15 x 120 cm	2 pcs.
roof	dim.: 30 x 30 x 60 cm	2 pcs.
half tire	dim.: 30 x 30 cm	2 pcs.
mini bridge	dim.: 30 x 60 x 30 cm	2 pcs.
small roof	dim.: 42 x 85 x 30 cm	2 pcs.

4528500

Cover for soft foam set I

Dim.: 120 x 60 x 210 cm

4521337



Made of foam, trimmed
with artificial leather.

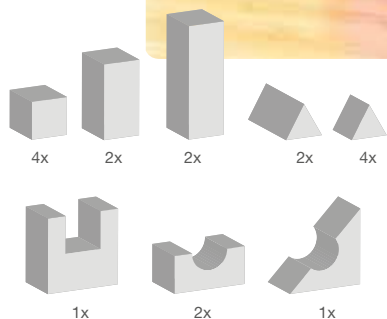

Soft foam set II

long beam dim.: W. 30 x H. 30 x L. 120 cm, 2 pcs.
small beam dim.: L. 60 x W. 30 x H. 30 cm, 2 pcs.
medium triangle dim.: L. 60 x W. 42 x H. 20 cm, 2 pcs.
short triangle dim.: L. 30 x W. 42 x H. 20 cm, 4 pcs.
small roof dim.: L. 85 x W. 30 x H. 42 cm, 1 pcs.
small cube dim.: L. 30 x W. 30 x H. 30 cm, 4 pcs.
mini cubes dim.: L. 60 x W. 30 x H. 30 cm, 2 pcs.
small base dim.: L. 60 x W. 30 x H. 60 cm, 1 pcs.

4521160

Cover for soft foam set II

Dim.: 60 x 80 x 150 cm

4522133



SOFT FOAM SET II

18 ELEMENTS



foam shapes, XXL blocks

CASTLE - SET OF BIG SOFT BRICKS

Made of foam, trimmed with artificial leather.

BESTSELLER

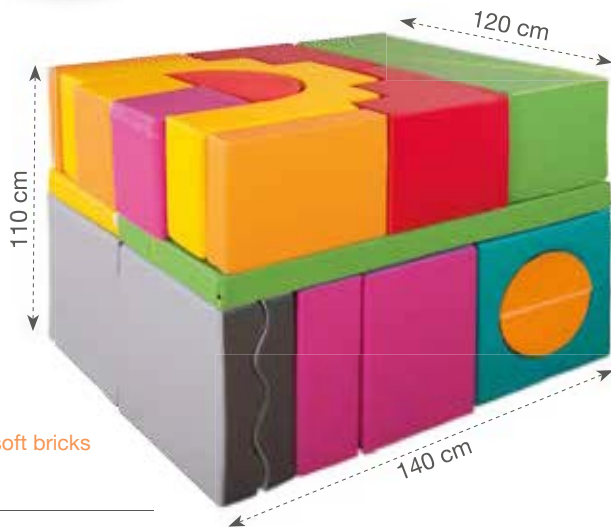

Castle - set of soft bricks
29 elements

4640630

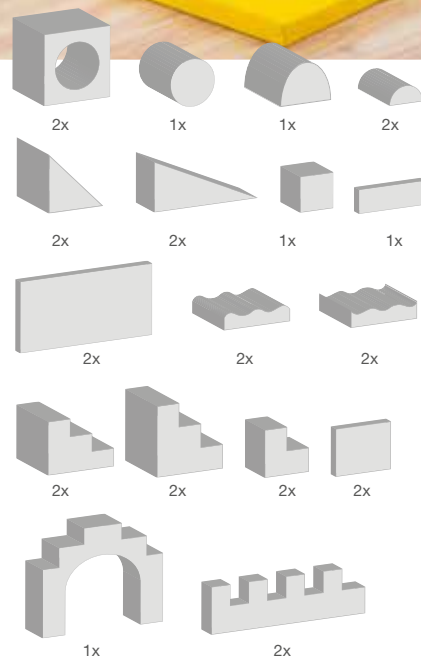

LARGE FOAM BLOCKS

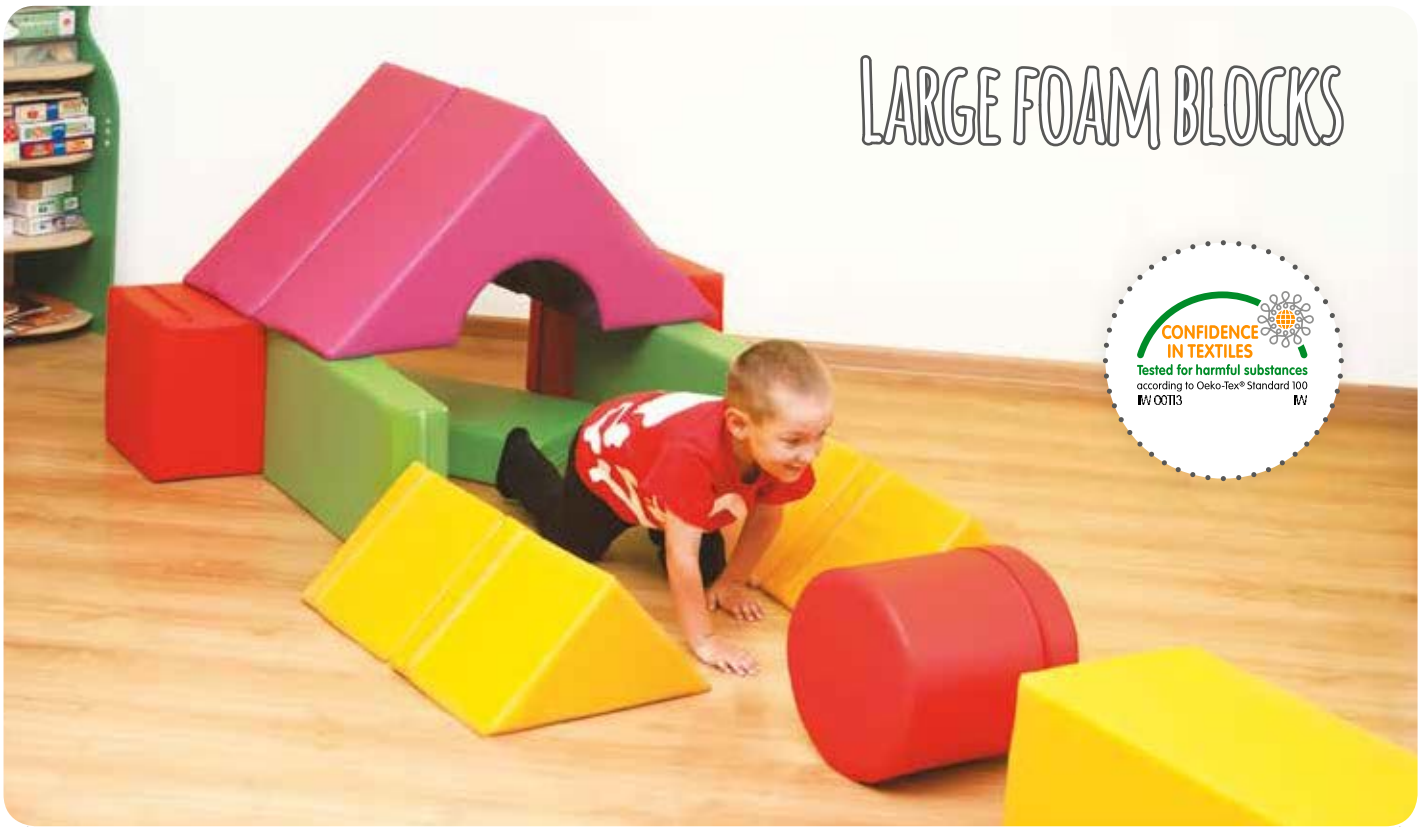

foam shapes, XXL blocks

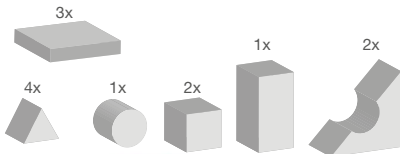

Mini tower soft foam set with cover

Set contains:

- small cube
- short triangle
- small beam
- small slice
- small roller
- small roof
- cover

- dim.: L. 30 x W. 30 x H. 30 cm, 2 pcs.
- dim.: L. 30 x W. 42 x H. 20 cm, 4 pcs.
- dim.: L. 60 x W. 30 x H. 30 cm, 1 pcs.
- dim.: W. 30 x H. 10 x L. 60 cm, 3 pcs.
- dim.: dia. 30 x H. 30 cm, 1 pcs.
- dim.: L. 85 x W. 30 x H. 42 cm, 2 pcs.
- dim.: L. 120 x W. 90 x H. 30 cm, 1 pcs.

4521126

BESTSELLER



Security provides
Oeko-Tex certificate





Plane - assembly instruction
4640999

I foams level

assembly instructions included

GREAT FUN WITH
THE PLANE!



Made of foam, trimmed with artificial leather.

Plane - foam set
Dim.: L. 365 x W. 300 x H. 100 cm

4640999

Cover bag available on request

BRIDGE SET

Made of foam, trimmed with artificial leather.

The bridge set was designed to encourage children to develop their dexterity and sense of balance and courage. It's not easy to overcome the obstacle that hangs at the height of 60 cm

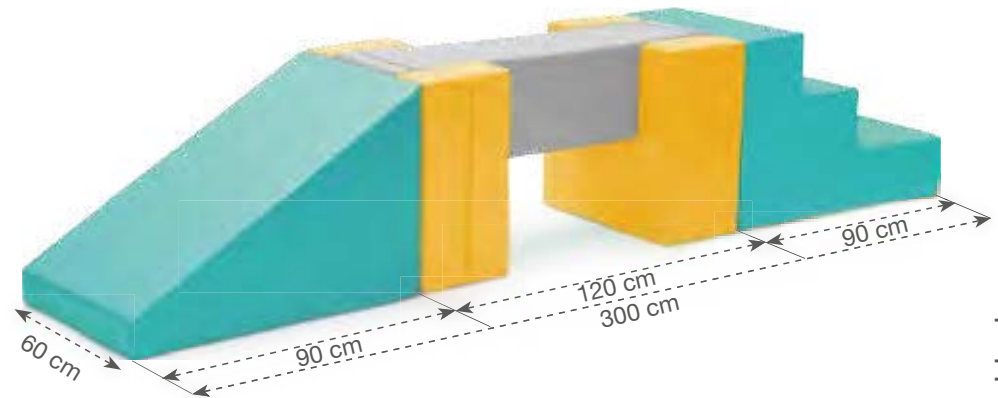
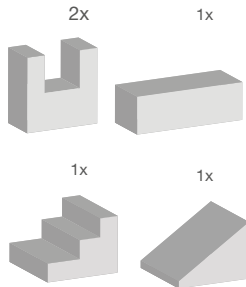

Bridge set

The set consists of 5 elements. Defeating the foam bridge requires lot of courage, (the beam is suspended at a height of 60 cm), as well as focus and concentration. Exercises on a balance beam help to develop a sense of balance and spatial orientation. Dim.: H. 60 x W. 60 x L. 300 cm

4641114

FOAM SEAT

Foam elements which can be used as a part of an obstacle course and also as a practical and comfortable seat.



Long beam

Dim.: H. 30 x W. 30 x L. 120 cm

4521001N blue

4640932 pink

4640970 green

4640971 gray



foam shapes, XXL blocks



PERFECT FOR GAMES AND PHYSIOTHERAPY EXERCISES



1



2



3



4

1. Small peak

Dim.: H. 42 x W. 30 x L. 85 cm

4521053

2. Peak

Dim.: H. 42 x W. 30 x L. 85 cm

4521102

3. Small holder soft foam

Dim.: H. 60 x W. 30 x L. 60 cm

4641113

4. Large base

Dim.: H. 60 x W. 60 x L. 60 cm

4521005

5. 1/2 tire

Dim.: dia. 30 x r. 15 x W. 30 cm

4521054

6. Small half cylinder

Dim.: H. 30 x W. 30 x L. 60 cm

4521063

7. Chest convex

Dim.: H. 30 x W. 60 x L. 60 cm

4521105



5

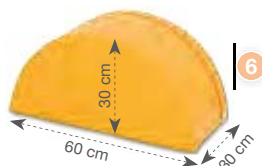

6



7



8



9



10

8. Small ramp

Dim.: W. 60 x H. 30 x L. 90 cm

4521015

9. Large ramp

Dim.: W. 60 x H. 60 x L. 90 cm

4641111

10. Straight stairs

Dim.: W. 60 x H. 60 x L. 90 cm

4641112



11



12



13

11. Semicircular convex stairs

Dim.: W. 60 x H. 60 x L. 90 cm

4521017

12. Semicircular concave stairs

Dim.: W. 60 x H. 60 x L. 90 cm

4521018

13. Wave

Dim.: W. 60 x H. 60 x L. 90 cm

4521020

1. Cube

Dim.: L. 60 x W. 60 x H. 60 cm, hole dia. 45 cm

4521096

2. Cylinder

Dim.: L. 60 x dia. 15 cm

4521057

3. Small tire

Dim.: dia. 60 x inner dia. 30 x W. 30 cm

4521006

4. Big roller

Dim.: dia. 60 x L. 60 cm

4521008

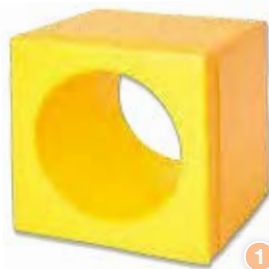

Foam shapes which can be used as seats, arranged into various obstacle courses, or configured into many combinations. Different sizes of the shapes allow the choice depending on the age and skills of users.

5. Small cube

Dim.: W. 30 x H. 30 x L. 30 cm

4521049

6. Cube

Dim.: H. 60 x W. 60 x L. 60 cm

4521012

7. Small beam

Dim.: H. 30 x W. 30 x L. 60 cm

4521050

8. Long beam

Dim.: H. 30 x W. 30 x L. 120 cm

4640971



9. Short triangle

Dim.: H. 20 x W. 42 x L. 30 cm

4521048

10. Long triangle

Dim.: H. 20 x W. 42 x L. 120 cm

4521003

11. Medium triangle

Dim.: H. 20 x W. 42 x L. 60 cm

4521051



12. Small roller

Dim.: dia. 30 x L. 30 cm

4521047

13. Medium roller

Dim.: dia. 30 x L. 60 cm

4521052

14. Long roller

Dim.: dia. 30 x L. 120 cm

4521002





NOVUM NEDERLAND

Ronde tocht 7a
1507 CC Zaandam
Nederland

Tel. 075 303 03 74

E-

mail:info@novumvoorkids.nl

www.novumvoorkids.nl



**Wij exporteren in Nederland en
zijn officieel dealer.**